

SPECIFICATIONS

Dominator XXXL® 8 Inch Air-Cooled Reflector

Item #904420

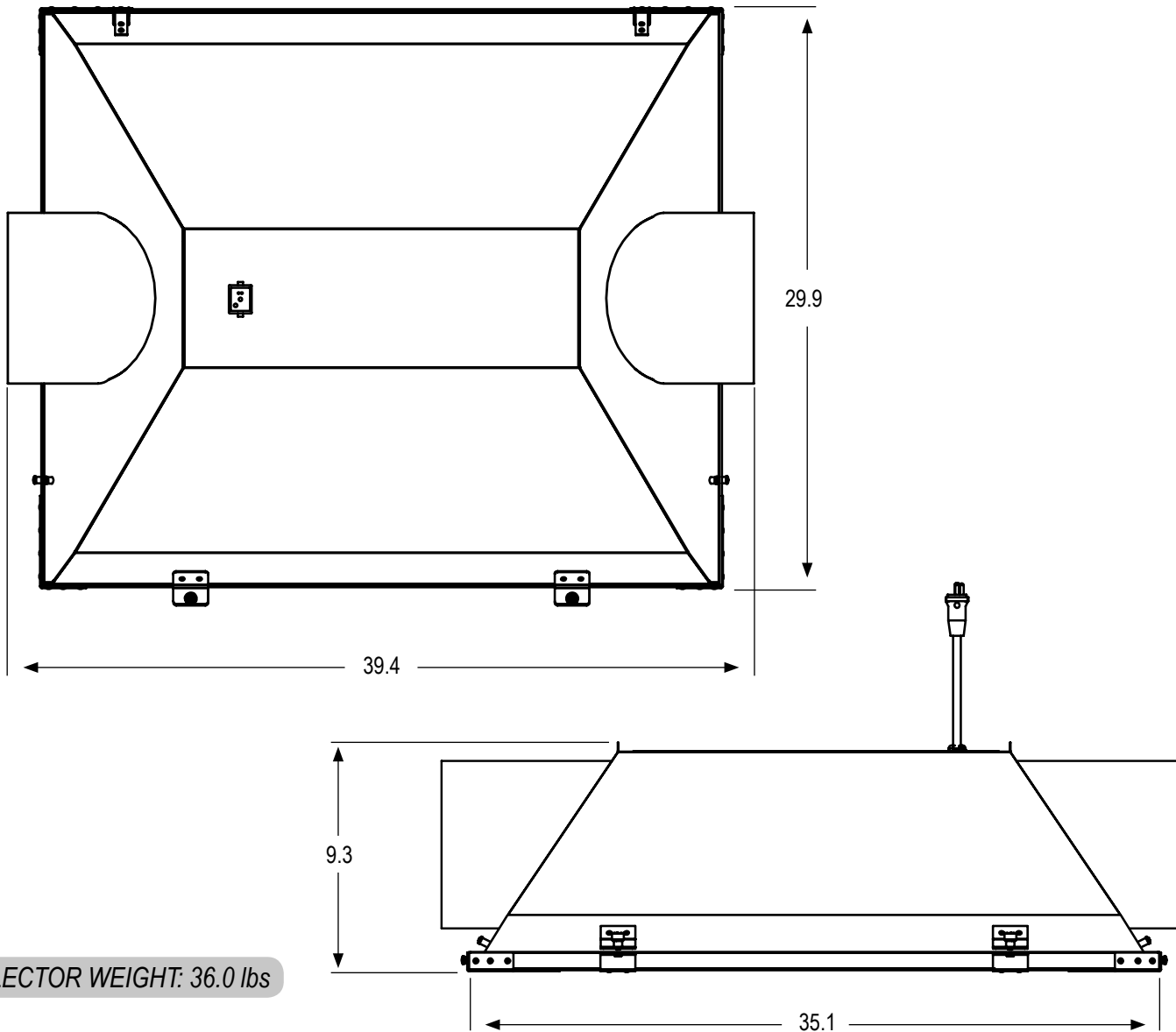

REFLECTOR WEIGHT: 36.0 lbs



This document is not intended to be used for installation purposes. We cannot cover all specific applications or anticipate all requirements. All specifications are subject to change without notice.

• = yes

•	ETL LISTED
	NOT ETL LISTED
Tested to UL Standard #1598	
•	AIR-COOLED
•	ACCEPTS GLASS
•	HINGED GLASS FRAME
	DETACHABLE LAMP CORD
•	600 VOLT RATED CORD
	FABRICATED IN USA*
•	5 YEAR WARRANTY
BALLAST COMPATIBILITY	
•	HPS
•	MH
Max. Wattage: 1500	
LAMP COMPATIBILITY	
•	HPS
•	MH
Max. Wattage: 1500	
LAMP POSITION	
•	HORIZONTAL
	VERTICAL
LAMP SOCKET TYPE	
	INTEGRATED DOUBLE-ENDED
•	INTEGRATED 5KV MOGUL BASE

* with US and globally sourced parts