



For integration
with any Bluelab® doser



FREE
Bluelab® connect™ stick
included (MSRP \$150 USD)



(6 months for pH probe)

Probe cable lengths:
2 meters / 6.5 feet



Contents

	page		page
1.0 Introduction & Overview:		4.0 Multi-part Nutrient Dosing:	
1.1 Features	3	4.1 Reservoir size	21
1.2 What's in the box?	3	4.2 Starting with multi-part nutrient dosing	22
1.3 How the BlueLab® Pro Controller works	4	4.2.1 Setting up the PeriPods™	22
		4.2.2 Setting up Connect	23
		4.2.3 Calculating the on time with multi-part nutrients	24
2.0 Set up:		5.0 Alarms & External Lockout:	
2.1 Set up the BlueLab® Connect™ Software	7	5.1 Connecting alarm & external lockout cable	25
2.2 BlueLab® Pro Controller connection panel	7	5.2 Alarm & external lockout cable functionality	25
2.3 Connect the probes	7	5.3 External lockout indicator	27
2.4 Power up	8		
2.5 BlueLab® Pro Controller control panel	8	6.0 Probe Care:	
2.6 BlueLab® Pro Controller modes	9	6.1 BlueLab® pH Probe care	28
2.6.1 monitor only	9	6.2 Cleaning the pH Probe	29
2.6.2 units	10	6.3 Hydrating the pH Probe	29
2.6.3 control direction	10	6.4 Cleaning the BlueLab® Conductivity Probe	30
2.6.4 required / alarms	11		
2.6.5 on times	13	7.0 Troubleshooting & Specifications:	
2.6.6 off times	14	7.1 Troubleshooting guide	31
2.6.7 calibrate	14	7.2 BlueLab® Pro Controller status displays	32
2.6.8 control	17	7.3 Technical specifications	34
3.0 Installation:		8.0 Accessories, Parts & Guarantee:	
3.1 Mount the BlueLab® Pro Controller	18	BlueLab® accessories & parts	35
3.2 Placement of the probes	18	BlueLab® limited warranty	37
3.3 Brightness control	19	Contact details	38
3.4 Manual override control	19		
3.5 Connecting dosers	19		
3.6 Record your system set up	20		

1.0 Introduction & Overview

1.1 Features

ONE BlueLab® Connect™ Stick included. Use with multiple BlueLab® Connect™ products	Data logging capability (download Free BlueLab® BlueLab® Software)
Local and remote adjustment of control settings via BlueLab® Connect™ software	Bright, plant safe green LED with adjustable brightness
Easy to navigate menu to program and adjust settings	Simple push button pH calibration
High and low alarms stop further dosing	Auto resume dosing on restart after power loss
Compressor protection on temperature control	Use BlueLab® Powerpod™ to connect to other mains operated dosers
Dosing lockouts to protect from over-dosing	Separate stainless steel BlueLab® Temperature Probe
Control of temperature requires use of BlueLab® Powerpod™	Large, easy to read displays
Water resistant, wall mount design	Replaceable double junction BlueLab® pH Probe
Replaceable BlueLab® Conductivity Probe	

1.2 What's in the box?

Please check and verify the box contents match the below list:

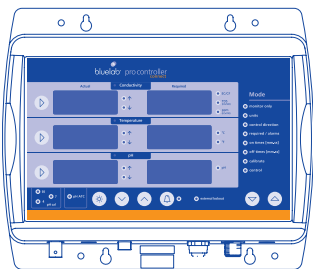

BlueLab® Pro Controller™



Getting Started Guide



BlueLab® Conductivity Probe

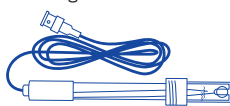

BlueLab® pH Probe



BlueLab® Temperature Probe



BlueLab® Connect™ Stick & Getting Started Guide



24V DC 0.4Amp power supply



Europe



UK



North America



NZ/Aus



Dosing cable



Alarm & External Lockout Cable



Solution sachets 3 each of pH 7.0, pH 4.0, EC 2.77



4x mounting screws

1.3 How the Bluelab® Pro Controller works

The Bluelab® Pro Controller is designed to continually monitor and control the conductivity, temperature and pH values of a solution.

It measures these using a separate probe for each and using a connected dosing system it can dose nutrient and pH correction solutions. The Bluelab® Pro Controller may also control a heating or cooling system via a connected Bluelab® PowerPod™.

Actual readings / values

These are the current values measured by the conductivity, temperature, and pH probes.

Required readings / values

These are the target values or set points the Bluelab® Pro Controller will maintain within the reservoir for conductivity, temperature, and pH.

Dosing cycles

Automated control of conductivity, pH and temperature is achieved by dosing. The Bluelab® Pro Controller does this with a dosing cycle method that consists of an On time and an Off time.

The **On time** is the length of time that nutrient or pH stock solution is dosed into the reservoir in each dosing cycle. Or in the case of temperature, how long the heater or cooler is turned on for.

The **Off time** is the delay time between each dose (or On time). This gives the system time to mix the stock solution into the reservoir thoroughly, so that the Bluelab® Pro Controller measures the solution accurately before it determines if the required values have been reached. In the case of temperature the Off time allows time for changes in temperature to equalise throughout the reservoir before heating or cooling is triggered again.

1 To find the on time for your system.

As a guide, three dosing cycles should change the reservoir by 0.1 EC (50 TDS, 70 ppm) or 1 °C (~2 °F) or 0.1 pH points over around three dosing cycles.

IMPORTANT

If the On time is too short, it is possible that the Bluelab® Pro Controller won't be able to dose enough to keep up with the changing nutrient/pH levels, even if it doses every dosing cycle.

If the On time is too long, the value is likely to overshoot; i.e. a single dose changes the value so much it goes over the desired value.

2 Setting Off Times

The dosing Off time needs to be long enough to allow thorough mixing of the dosed solution in the reservoir. Start with a longer off time and reduce it over time. Mixing times (and therefore the off time) can be reduced by installing mixing pumps, air injection or other mechanical means of mixing into the reservoir.

IMPORTANT

If the Off time is too short, the pH or nutrient stock solution will not have been properly mixed in the reservoir. The Bluelab® Pro Controller may dose again, which can result in overshoot of the required value.

If the off time is too long, it is possible that the nutrient/pH levels may change too much between doses.

Hint: The mixing time of the reservoir can be estimated by manually adding sufficient nutrient to significantly shift the conductivity value, while timing how long it takes from adding the nutrient, to when the conductivity value becomes stable.

1.3 How the Bluelab® Pro Controller works continued

Dosing lockouts

Some conditions will cause the Bluelab® Pro Controller to stop controlling. These are called dosing lockouts. This is how the five types of dosing lockouts work:

1 Measurement range limits

Each of the measurement types (conductivity, temperature and pH) have a measurement range within which they can measure. Conductivity, for example, can be measured between 0.0 EC and 5.0 EC; temperature between 0°C and 50°C.

If values outside these limits are sensed, the Pro Controller will indicate that it is under or over range by flashing the display, and displaying “ur” or “or” in the affected measurement type. Dosing will immediately stop in that measurement type. pH “or/ur” will also stop the EC dosing.

2 Alarms

When alarms are turned on, and the Bluelab® Pro Controller senses that either EC or pH is beyond the set high or low alarm values, all nutrient dosing will stop (both EC and pH). Temperature is independent of EC and pH. The Bluelab® Pro Controller will indicate that it is in alarm by flashing the display, and displaying a code in the affected measurement type - for example “EC LO” to indicate that the conductivity has reached the low alarm value.

IMPORTANT

Alarms are not just warnings that values have shifted away from the required value - they stop dosing. Be careful not to set alarm values which are too close to the required values, as they may result in the Bluelab® Pro Controller going into alarm because of small variations in measured values.

When the values return to within the limits of the set alarms, the alarm state ceases, and after a 60 second countdown, the Bluelab® Pro Controller begins controlling again, dosing as required. The alarm state can also be cancelled by switching alarms off (pressing the alarm button, or switching alarms off via Connect). After a 60 second countdown the Bluelab® Pro Controller will begin controlling again.

3

Ineffective Control Lockout

The Bluelab® Pro Controller continually checks to ensure that dosing is having an effect. It will go into lockout if 15 dosing cycles of any of the three measurement types (conductivity, temperature or pH) do not move the measured value by at least 0.1 EC, 1°C, or 0.1 pH in the desired direction. This is called the ineffective control lockout, and is enabled by default, but can be disabled via the Bluelab® Connect™ Software.

The Bluelab® Pro Controller will indicate it is in ineffective control lockout by flashing the display, and displaying a code in the affected measurement type - for example “PH IC” to indicate that pH is in ineffective control.

IMPORTANT

The ineffective control lockout is useful to stop dosing pump operation if stock solution tanks have emptied, or a hose has fallen out of a reservoir, for example.

However for a batch dosing system where fresh water is being added to the reservoir at the same time as dosing is occurring, it may be better to disable this feature.

1.3 How the Bluelab® Pro Controller works continued

Dosing lockouts continued

4 Low EC Lockout

The Bluelab® Pro Controller will stop dosing nutrient solution if the measured conductivity drops below 0.2EC (2CF, 100TDS, 140ppm). This is called the Low EC Lockout, and is enabled by default, but can be disabled via the Bluelab® Connect™ Software.

The Bluelab® Pro Controller will indicate it is in low EC lockout by flashing the conductivity display, and displaying “EC 0.2LO.” As soon as the measured conductivity rises above 0.2, the Pro Controller will resume dosing again after a 60 second countdown.

IMPORTANT

The Low EC Lockout is useful to stop dosing if the conductivity probe is taken out of the reservoir, or if the solution level falls below the probe level.

However when dosing into fresh, RO or deionised water is required this lockout may need to be disabled.

5 External Lockout

Dosing can be stopped by external flow switches, float switches, or other sensors connected to the Bluelab® Pro Controller via the Alarm and External Lockout cable. This is called an external lockout.

When the Pro Controller is in external lockout, the external lockout LED will light, and the displays will flash “EL” and either “nc” or “no,” depending on which switch has been activated.

As soon as the switch position returns to normal, the Bluelab® Pro Controller will resume controlling after a 60 second countdown.

IMPORTANT

The External Lockout feature can be used to stop dosing when a tank level gets too low, a pump stops, or solution feeding out is taking place.

Please refer to these sections of the manual for more information:

- Section 7.2 - Bluelab® Pro Controller status displays
- Section 5.0 - Alarms and External Lockout

2.0 Setting up the Bluelab® Pro Controller

2.1 Set up the Bluelab® Connect™ Software

- 1 Prior to installing, note the 4 character KEY CODE on the base of the Bluelab® Pro Controller, just above the serial number.

key code: abcd

- 2 Download the latest Connect™ software from <https://www.bluelab.com/products/type/connect-suite/connect-software.aspx>



- 3 Power up the Bluelab® Pro Controller near your computer with the Connect™ Stick fitted. Add the Bluelab® Pro Controller as a device. See section 2.4 for instructions on powering up the Bluelab® Pro Controller.

2.2 Bluelab® Pro Controller connection panel

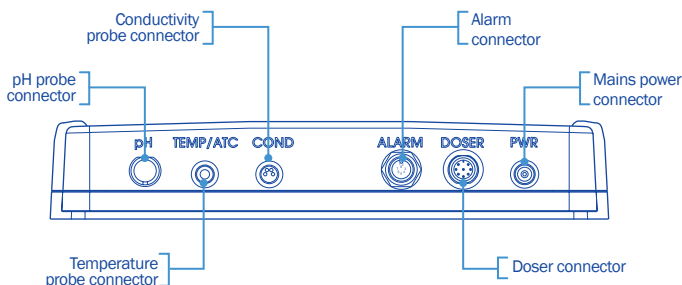

2.3 Connect the probes

It is recommended to test the Bluelab® Pro Controller prior to mounting. Attach all three probes to the controller, plug in the power adaptor, place probes into solution and wait a few minutes for the readings to stabilise.

- 1 **pH Probe**
Line up the lugs of the BNC probe connector with the receptacle on the Bluelab® Pro Controller labelled 'pH'. Fasten securely by pushing the pH probe connector on and twisting one quarter turn.

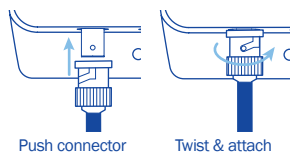

- 2 **Conductivity Probe**
Line up the four pin connector on the conductivity probe with the receptacle on the Bluelab® Pro Controller labelled 'COND'. Push and screw the collar fully into the receptacle.

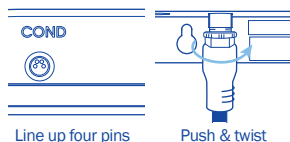

- 3 **Temperature Probe**
Fully insert the temperature probe connector into the Bluelab® Pro Controller receptacle marked 'TEMP/ATC'.

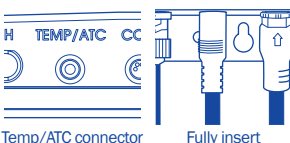



2.4 Power up

- 1 Select and connect the appropriate mains plug adaptor for your country to the power supply unit.

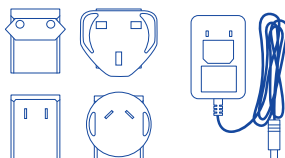

- 2 Connect the power adaptor into the Bluelab® Pro Controller receptacle marked 'PWR'.



- 3 Plug the power adaptor into a mains outlet and switch it on. The Bluelab® Pro Controller will complete a display test sequence.

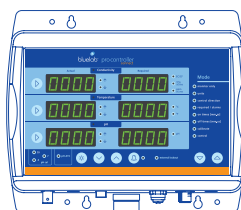

- 4 The default setting, when the unit is first powered up, is 'monitor only' mode.

Note: pH calibration should be completed before first use to ensure pH readings are accurate.

2.5 Bluelab® Pro Controller control panel

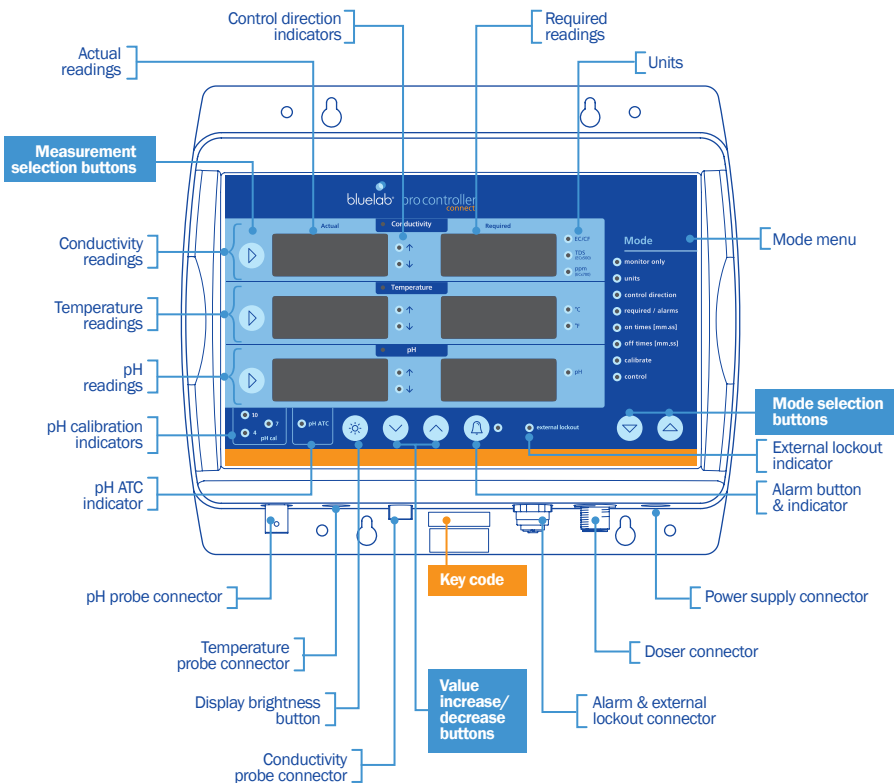

2.6 Bluelab® Pro Controller modes

Easy navigation

The Bluelab® Pro Controller has two modes of operation (monitor and control) and six set-up modes.

Use the **Mode Selection** buttons ('▽' and '△') to select the mode. Once in the required mode, select the measurement to adjust with the **Measurement Selection** buttons ('▷') and adjust the value up and down with the **Value Increase/Decrease** buttons ('▲' and '▼').

We recommend familiarising yourself with the different settings before installing/ mounting the controller.

The Mode is selected using the Mode Selection buttons below the Mode menu.



Mode

- monitor only
- units
- control direction
- required / alarms
- on times [mm:ss]
- off times [mm:ss]
- calibrate
- control

2.6.1 monitor only

Monitor only mode shows only the actual values/readings from the conductivity, temperature and pH probes. No control action occurs.

Mode

- monitor only



Monitor only mode selected



2.6.2 units

Units mode allows the units of measurement to be changed for conductivity and temperature.

- 1 Select 'Units' mode.
- 2 Select measurement to adjust ('▷').
- 3 Press the value increase/decrease buttons to select the desired unit of measurement.

Note: To change between EC and CF, press the measurement button twice when this indicator is lit. CF is 10x EC e.g. 2.8EC = 28CF. pH has no selectable units.

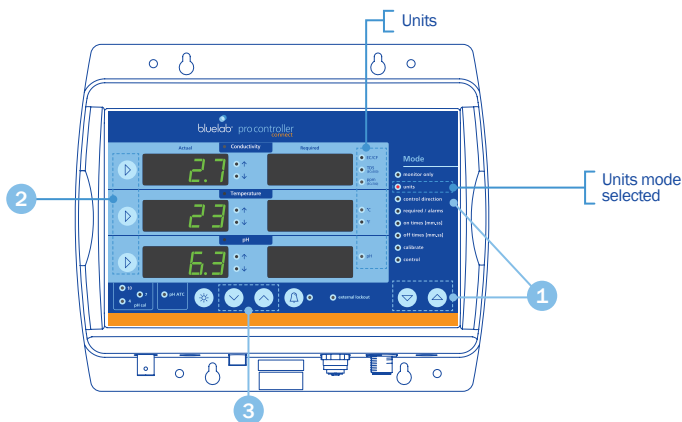

2.6.3 control direction

Control Direction mode allows the dosing direction to be set for the measurement value.

- 1 Select 'Control Direction' mode
- 2 Select measurement to adjust ('▷')
- 3 Press the value increase/decrease buttons to change the control direction

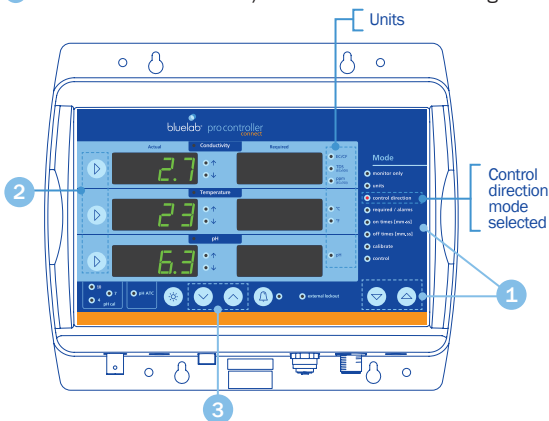

Control direction options:
Raise ↑ or lower ↓ or OFF

Note: OFF means that control of this measurement is turned off. This allows some measurements to be controlled while others are just monitored.

IMPORTANT

The control direction for each measurement value must be selected based on the requirements of the system, and the correct stock solutions, pH adjusters and temperature device must be used.



2.6.4 required / alarms

This mode is used to set the 'required' or 'target' levels for conductivity, temperature and pH in your system. It is also used to set alarm levels.

'Required' is the value you need the BlueLab® Pro Controller to maintain through dosing.

High and low alarm levels can be set. Alarms can be turned on or off in any mode with the Alarm button. The LED indicator next to the Alarm button indicates whether alarms are switched on.

Setting conductivity, temperature and pH required and alarm levels.

- 1 Select 'Required/alarms' mode.
- 2 Select the measurement to adjust ('▷')
(see following page for setting temperature values).
- 3 Press the same measurement selection button to toggle between the following values; required level (rd) for conductivity and pH, on and off values for temperature, high alarm value (AL.HI), and low alarm value (AL.LO) for that measurement.

The value selected to edit will be displayed brightest.

- 4 Adjust values using the value increase/decrease buttons.

Note: If the value you are changing reaches another alarm high, alarm low or required value, it will be automatically pushed so they do not overlap.

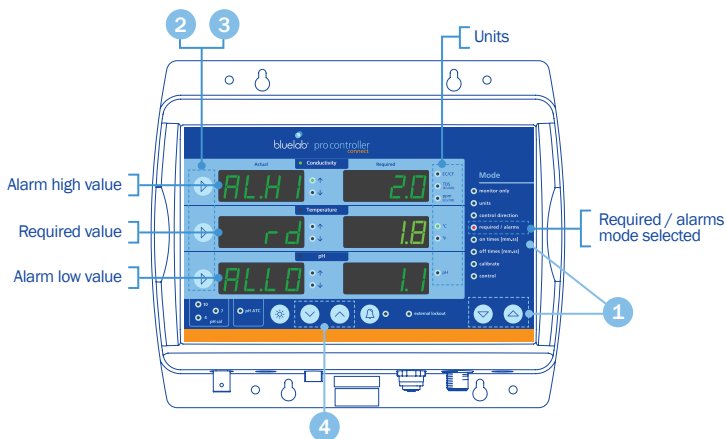

IMPORTANT

For more information on setting the temperature on and off values, please refer to the next page.

2.6.4 required / alarms continued

Temperature required / alarms

Temperature is difficult to maintain at a constant level using on and off times, so the BlueLab® Pro Controller manages it differently to conductivity and pH.

It is normal practice to set the temperature on time to 'continuous', which allows the heater/cooler to operate until the temperature off value is reached.

For example, if you are heating a tank or reservoir, when the "temperature on" value is reached, heating will be turned on. When the "temperature off" value is reached, it will be turned off.

To set the temperature values, refer to steps 1-4 on the previous page.

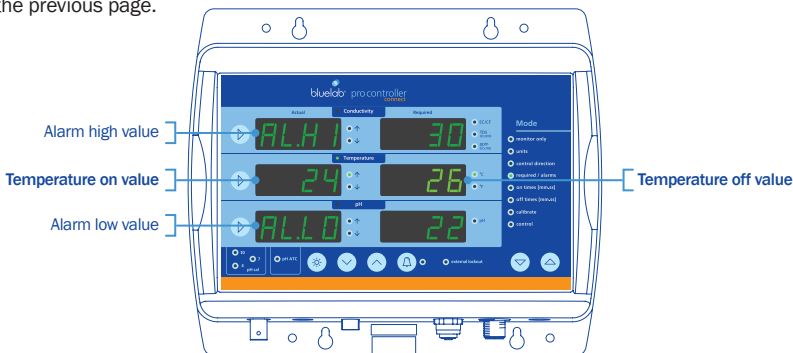
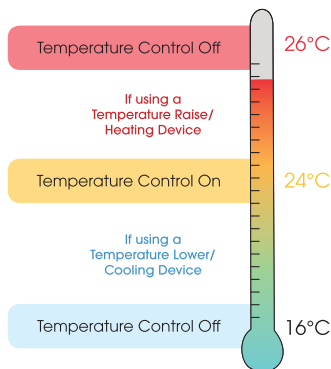

Alarm 'Quick-set'

Use the Quick-set features to quickly set the "required", "alarm high" and "alarm low" values for all three measurements. The required and alarm values are taken from the actual current readings, so ensure your system is stable before using the Quick-set function.

- 1 In 'Required / Alarms' mode select the measurement you want to 'quick-set'.
- 2 Press the alarm button.
- 3 Quick-set only sets the required and alarm values for the selected measurement, so repeat steps 1 & 2 for the other measurements required.

This table shows the values that are applied when 'quick-set' is used.

'Quick-set' Alarm Values

	Alarm Low	Required	Alarm High
Conductivity	Actual value - 2 CF / 0.2 EC 100 TDS 140 ppm	Actual value	Actual value + 2 CF / 0.2 EC 100 TDS 140 ppm
Temperature	Actual value - 3°C / 5°F	Actual value	Actual value + 3°C / 5°F
pH	Actual value - 0.5pH	Actual value	Actual value + 0.5pH

2.6.5 on times

The on time can be set from one second to ten minutes in one second intervals. During dosing on time, the dose direction indicators next to the Actual values will flash.

For information on calculating on times for multi part nutrients see section 4.2.3

Setting 'On Times'

- 1 Select 'on times' mode.
- 2 Select measurement to adjust ('▷').
- 3 Press (or hold down) the Value Increase/Decrease buttons to change the on time value.

Note: 0 seconds = continuous (cont), which means the BlueLab® Pro Controller will dose until the required value is reached WITHOUT stopping to allow the tank to mix. This should only be used under special circumstances, as unless closely monitored, overshooting is likely.

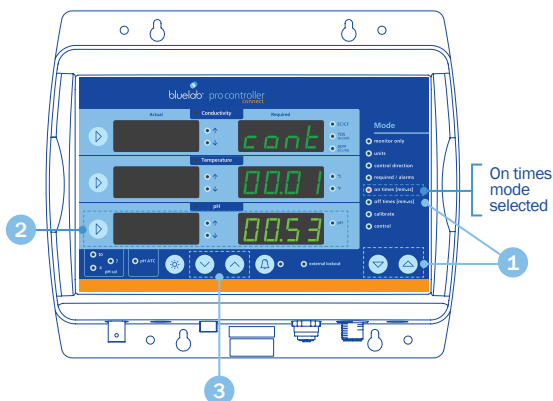

Programmable from 0-10 minutes
in one second increments.

The ideal on time is the time that the doser has to dose for (pumps actually running), in order to shift the EC by just less than 0.1 EC. Any more than 0.1EC, and the EC can overshoot, as one dose may take it over the required value. Any less will increase the time the system needs to dose up to the required levels. If time to reach the required EC level is not very important (recirculating systems change slowly, and can be corrected slowly) a shorter on time (maybe 2 or three doses to lift the EC by 0.1) is fine.

The on time for pH will be quite different to EC, so will need to be found in the same way, but shifting 0.1 pH instead.

- **Slowly** add equal parts of the nutrient that will be used in **small quantities**, and wait for it to mix. Keep adding small quantities like this, waiting for it to mix each time, until the EC reading **just increases to the next 0.1 step**.
- Now, **measuring exactly how much you are adding**, add small equal quantities of nutrient, again waiting for it to mix after each addition, until the EC reading **just reaches the next 0.1 step**.
- The amount of nutrient added to reach the **second step from the first** is the amount needed to **shift the EC by 0.1**.
- Work out **how long the doser has to run** to deliver that quantity. For example, **140 mls** of each nutrient was required to produce this shift. For an M3 PeriPod™ (120mls per minute per pump = 2 mls per second), then **70 seconds is required**. **60 seconds** (slightly less than this) would be a good on time.



2.6.6 off times

The 'off time' is the delay time between each dose which allows the tank to thoroughly mix, and for EC & pH readings to stabilise. The 'off time' can be set from 1 to 60 minutes.

Start with a long 'Off Time' and reduce gradually, ensuring the system is not overshooting. The more thorough the mixing in the tank, the shorter the 'Off Time' can be.

Setting 'Off Times'

- 1 Select 'off times' mode.
- 2 Select measurement to adjust ('▷').
- 3 Press (or hold down) the Value Increase/Decrease buttons to change the off time.

Programmable from 0-59 minutes and 50 seconds in ten second increments.

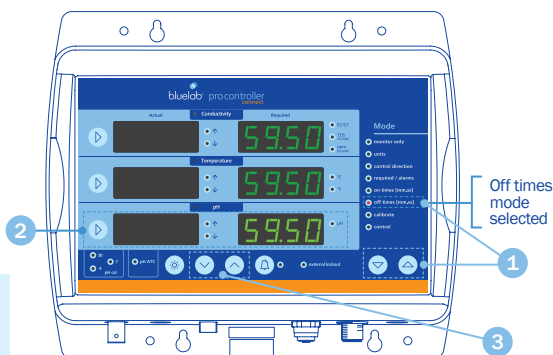

2.6.7 calibrate

Calibrate mode allows calibration of the BlueLab® Pro Controller to conductivity and pH probes.

- 1 Select 'Calibrate' mode.
- 2 Select measurement to calibrate ('▷').
- 3 Follow the directions below to calibrate conductivity or pH.



2.6.7 calibrate continued

Conductivity calibration

The Conductivity probe is factory calibrated. It is unlikely that you will need to calibrate it, but it can be calibrated if required.

For accurate calibration and measurement the probe should be cleaned before calibration. See Conductivity probe cleaning in Section 6.4.

Conductivity accuracy is dependent on the accuracy of the calibration solution used.

Conductivity solution should always be fresh.

- 1 **Ensure the probe has been cleaned, and rinsed well with fresh water.**

Shake as much water as possible off the probe. Water still on the probe after rinsing can lower the reading, and cause an inaccurate calibration.



clean the conductivity probe



2.77 EC Conductivity Standard Solution

- 2 **Place some 2.77 EC calibration solution into a clean dry container.**

Place the conductivity probe into the solution, and wait a few minutes to allow the probe to reach the same temperature as the solution.

- 3 **Select calibrate mode.**

Press the conductivity measurement button. The current reading will be shown on the actual display, and EC CAL on the right. A calibration offset value will be displayed brighter than the other numbers at the top of the right hand display.



- 4 **Calibrate by pressing the value increase/decrease buttons to bring the actual reading to the value of the calibration solution.** Each press of the buttons will shift the reading by 0.1EC. The calibration offset value will also increase or decrease as this is done.

- 5 **When the actual value is the same as the calibration solution (2.8 EC), press the mode select buttons to exit calibration mode.** This saves the calibration, and calibration is complete.

Note: For Bluelab® 2.77 EC solution, a display of 2.8 EC should be expected.

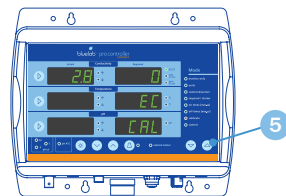



2.6.7 calibrate continued

pH calibration

pH calibration is important before first use.
It ensures pH measurements and dosing are accurate.

For accurate pH readings the pH probe should be cleaned and calibration carried out when:

- it has been 30 days since the last pH calibration, and the calibration indicators are flashing.
- the reading is different to what you were expecting.
- the BlueLab® Pro Controller is reset to factory default, and the calibration indicators are not lit.
- the pH probe is replaced with a new one.

If the pH probe has been in use it should be cleaned before pH calibration. See section 6.2 for pH probe cleaning. New pH probes do not need to be cleaned.

If you are calibrating to TWO points, remember:

If a reading below pH 7.0 is expected, use pH 7.0 and pH 4.0 calibration solutions.

If a reading above pH 7.0 is expected, use pH 7.0 and pH 10.0 calibration solutions.

Three point calibration would be recommended if:

Readings above and below pH 7.0 are expected. Use pH 7.0, pH 4.0 then pH 10.0 calibration solutions.

To carry out pH calibration:

The conductivity probe is required to be in the solution to ensure accurate pH calibration and measurement. The solution temperature is measured with the conductivity probe, not the temperature probe.

1 Clean pH probe tip if required.

Refer to Section 5.2 for pH probe cleaning.

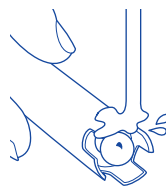

clean the pH probe

2 Select Calibrate mode.

Placing in 'Calibrate' mode will stop all dosing.

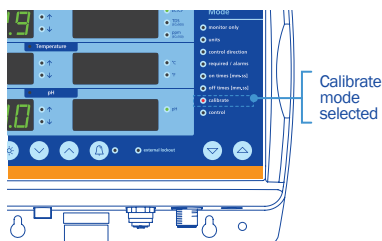

3 In several separate plastic containers, prepare a small amount of: fresh tap water, pH 7.0, pH 4.0 and/or pH 10.0 calibration solutions.



2.6.7 calibrate continued

pH calibration continued

4 pH 7.0 calibration

- Rinse pH and conductivity probes in fresh water and place both probes in a small amount of fresh pH 7.0 calibration solution.
- Wait a few minutes for the probes to come to the same temperature as the solution.
- Press and hold the pH measurement button and wait for PH CAL to be displayed. Release button.
- PH 7 and the first '[]' will flash on screen. Calibration is now in progress.
- When all 4 '[]' have appeared, PASS or FAIL will be displayed. PASS indicates a successful calibration at pH 7.0, and the pH 7 LED will be displayed. If FAIL is displayed, see section 6.0.

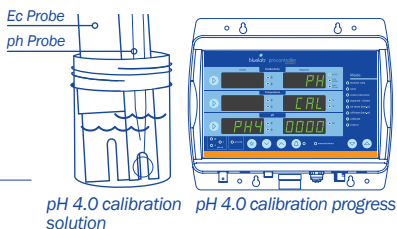
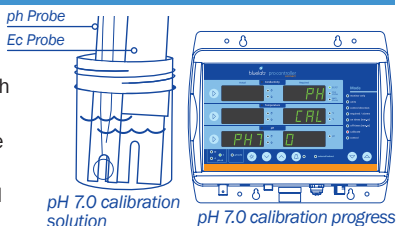

5 pH 4.0 and/or pH 10.0 calibration

- Rinse pH and conductivity probes in fresh water, place both probes in a small amount of fresh pH 4.0 or pH 10.0 calibration solution.
- Wait a few minutes for the probes to come to the temperature of the solution.
- Repeat the calibration steps above using pH 4 or pH 10 solution.
- If a 3 point calibration is required, (you are expecting to measure both above and below pH 7) repeat the calibration procedure with the remaining solution value.

The Pro Controller is now calibrated, and ready for use.

Calibration status

<input type="radio"/>	<input type="radio"/>	Using factory default calibration values
<input type="radio"/>	<input checked="" type="radio"/>	pH 7 calibrated ok
<input type="radio"/>	<input checked="" type="radio"/>	pH 7 & pH 4 calibrated ok
<input type="radio"/>	<input checked="" type="radio"/>	Indicators flashing - 30 days have passed since last full calibration. Calibration due

2.6.8 control

When in control mode, the Bluelab® Pro Controller monitors the actual readings from the probes and triggers dosing cycles to reach and maintain the measurement values set in the 'Required/Alarms' mode.

For dosing to occur a separate doser (not included) must be connected to the Bluelab® Pro Controller with the dosing cable provided.

- Select 'Control' mode.

- The Bluelab® Pro Controller triggers dosing in order to reach and maintain the nutrient, pH and temperature values set in the required/alarms mode.

When the system is dosing the control direction indicator LEDs will flash.

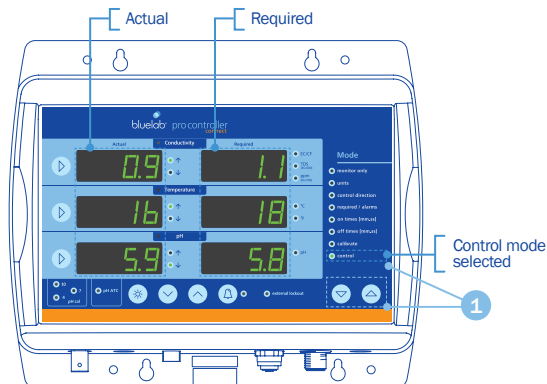

3.0 Installing the Bluelab® Pro Controller

3.1 Mounting the Bluelab® Pro Controller

- 1 Select a suitable location for the Pro Controller:
Pro Controller:
 - So the probes can comfortably reach the tank/reservoir or sample pot and be immersed in solution at all times.
 - Near an electrical mains outlet.
 - At a suitable height to see the display and for easy operation.
 - Position the Pro Controller away from direct sunlight and risk of water, nutrient or pH adjuster damage.

- 2 Fix the fasteners through the desired mounting holes in the top and bottom of the case.

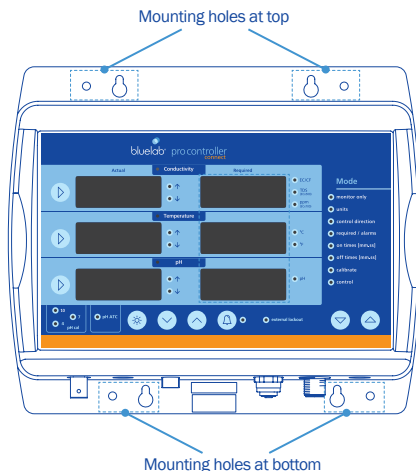

3.2 Placement of probes

All probes must be submerged in the solution for measurement. The Bluelab® conductivity probe measures solution temperature and provides automatic temperature compensation for the pH measurement. The temperature displayed on and controlled by the Pro Controller is the temperature measured by the Bluelab® Temperature probe.

- Do not pour concentrated nutrient solution or pH adjuster directly onto probes when in the reservoir, as very strong acid may damage the probes or trigger alarms.
- For accuracy, ensure the conductivity and pH probes are in an area where the reservoir/tank solution is well mixed or in a sample pot.
- If the Pro Controller is used to control solution temperature it should also be placed in the reservoir or sample pot. If used to control air temperature, it should be placed in an appropriate position outside the reservoir.

- 1 Remove the storage cap from the pH probe by gripping the top of the cap and gently twisting the base one rotation to loosen. Slide the storage cap off the pH probe.



- 2 Fit the (optional) pH probe holder to the stem of the pH probe using a gentle twisting motion. Be careful not to bend or flex the probe stem.

- 3 Place the pH probe into the tank/reservoir and push the suction cup onto the side of the tank/reservoir so the pH probe tip will stay submerged in the solution and will not get damaged. The pH probe can be fully submerged.

- 4 Place the conductivity probe (and the temperature probe, if used for solution temperature) into the tank/reservoir alongside the pH probe.

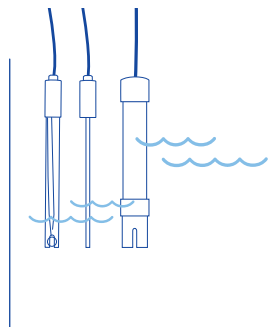



3.3 Brightness control

- 1 Press and hold down the brightness button.

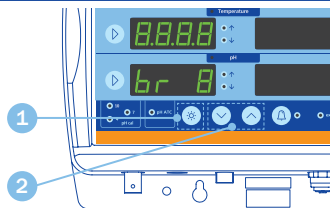

- 2 Adjust the brightness by using the increase/decrease buttons. This can be done at any time.

3.4 Manual override control

Manual override lets you manually dose conductivity, temperature or pH. This can be used to prime dosers or to manually bring a system to required levels quickly.

- 1 Select 'monitor' mode
- 2 Press and hold the measurement button of the measurement you want to dose.
- 3 Press both mode buttons together.
- 4 Continue to hold the measurement button while dosing, and release it to stop.



3.5 Connecting dosers

The Bluelab® Pro Controller must be connected to a Bluelab® doser (not included) via the dosing cable for dosing to occur. Up to three M3 or M4 PeriPods™ can be connected (daisy-chained) when dosing multi-part nutrients. Other mains-powered dosers and temperature control systems can be connected via the Bluelab® PowerPod™ (not included).

- 1 Line up the dosing cable connector with the receptacle on the Bluelab® Pro Controller labelled 'DOSER'. Push and screw the collar fully into the receptacle.
- 2 Connect the other end of the dosing cable to a Bluelab® doser or Bluelab® PowerPod™.

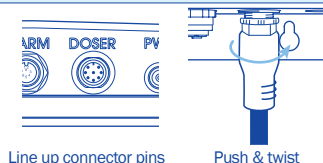

Note: Temperature control devices and mains powered pumps must be compatible with the Bluelab® PowerPod™. Please refer to Bluelab® PowerPod™ and third party product documentation before connecting these devices.



3.6 Record your system set up

Make a note of your system set up values here:

Conductivity

Temperature

pH

On times:

On times:

On times:

Conductivity

Temperature

pH

Off times:

Off times:

Off times:

Conductivity

Temperature

pH

Alarm High:

Alarm High:

Alarm High:

Required:

On:

Off:

Required:

Alarm Low:

Alarm Low:

Alarm Low:



4.0 Multi-part Nutrient Dosing with the BlueLab® Pro Controller

The BlueLab® PeriPods™ can be used with the BlueLab® Pro Controller and BlueLab® Connect™ to dose multi-part nutrients in varying proportions, according to a feed chart or feed schedule.

Up to three PeriPods™ can be daisy-chained, each having three or four pumps, giving up to 12 nutrient parts. M series PeriPods™ cannot be mixed with L series.

Overview of Multi-part nutrient dosing

Multi-part nutrient dosing allows dosing of nutrients into a reservoir according to a feed chart or feed schedule. These are often provided by the nutrient manufacturer.

FRODO'S FEED CHART			NUTRIENTS					
Week	Required pH	Required PPM	Macro A	Macro B	Mini Macros	Mega Micro 1	Mega Micro 2	Special Sauce
1	5.8	450	8 ml	8 ml	2 ml	1 ml		
2	5.8	650	10 ml	10 ml	4 ml	2 ml		
3	5.8	650	12 ml	12 ml	5 ml	2 ml		1 ml
4	5.8	1400	14 ml	14 ml	5 ml	5 ml		3 ml
5	5.8	1100	14 ml	14 ml	5 ml	5 ml		3 ml
6	5.8	1100	14 ml	14 ml	5 ml		5 ml	3 ml
7	5.8	800	12 ml	12 ml	5 ml		5 ml	3 ml
8	5.8	450	10 ml	10 ml	5 ml		5 ml	

*all measures in ml/US gal and ppm 500 scale

Multi-part nutrient dosing can be selected in **Connect™** when a suitable Pro Controller/PeriPod™ combination is detected. It is enabled in the Pro Controller **Nutrient Dosing** screen.

Each pump in the PeriPod™ or the PeriPod™ chain of up to three PeriPods™ can be set as a pH pump, an EC (nutrient) pump, or it can be turned off if not currently needed.

The nutrient proportions are calculated automatically from the feed chart quantities directly entered into **Connect™** by the user.

When the Pro Controller initiates dosing, the PeriPods™ use the calculated proportions to switch individual pumps on and off on during dosing, so that they dose the nutrients in the correct proportions. For example, if one pump is set to 10 ml/gal and another set to 5 ml/gal the first pump will dose for twice as long as the second pump.

When the nutrient proportions change (a new line or week in the feed schedule), **the reservoir should ideally be emptied**, filled, and dosed up using the new ratio. This avoids unwanted nutrients remaining in the reservoir, and smaller components taking too long to come to the correct concentrations.

4.1 Reservoir size

Because 100 seconds total dosing time is required in order for the PeriPod™ to accurately dose, it's clear that there is a minimum reservoir size required. If the reservoir doses up to the required EC before the 100 seconds dosing is up, the nutrients may not be properly balanced. If the reservoir that will be used is less than about 25 gallons (100 litres)(for an M series PeriPod™ chain), we suggest diluting all of the nutrient components by adding an equal volume of water. This will double the dosing time, ensuring that 100 seconds dosing time is achieved. Remember to label the containers to indicate that they are diluted.



4.2 Starting with multi-part nutrient dosing

Setting up the PeriPods and Connect

4.2.1 Setting up the PeriPods

IMPORTANT

The PeriPod™ doses small volumes of nutrient into the reservoir so results in less precipitating nutrients, but to further ensure this is minimised:

- Separate all nutrient tubes where they enter into the reservoir
- Always have sufficient and continuous mixing in the reservoirs (more is better)
- Some nutrient components or additives (e.g. silicon) are extremely prone to precipitation. Dilute precipitation prone nutrients or additives to very dilute levels before dosing. Multiply the dose value (ml/gal) by the dilution rate and enter into Connect™ to retain the same ratio. Continuous addition in dilute form results in some of the nutrient/additive always being available, even if precipitation over time is expected.

- 1 Mount the PeriPods™ as described in the PeriPod™ Manual.
- 2 Ensure each pump is drawing from the correct nutrient part. Labelling the pumps with the nutrient types in the feed chart is a good idea.
- 3 Connect the PeriPods™ in a daisy chain with the dosing cables. The dosing cable and the PeriPod™ connectors are colour coded to make this easier.

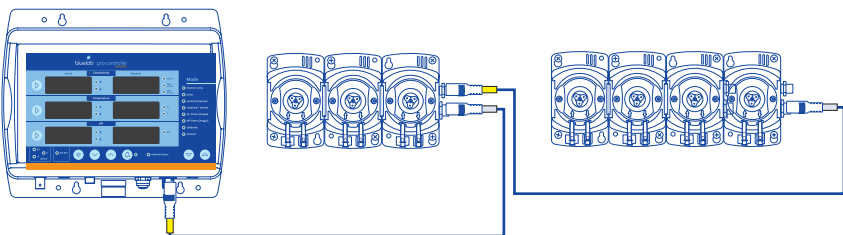

- 4 Ensure the Pro Controller and all of the PeriPods™ are powered up. If it is the first time the PeriPods™ have been connected to the Pro Controller, a “Pod Change – Accept” message will be displayed on the Pro Controller. Check that all of the PeriPods™ are correctly set up, powered up and connected, with all required nutrient parts and pH adjusters in place, then press the Pro Controller brightness button to “accept” the pod chain. This prompts the Pro Controller to “remember” the details of all of the pods and pumps, so it can communicate with them correctly.

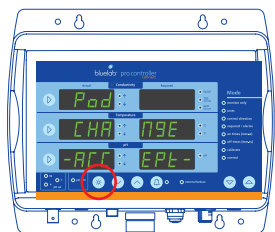

- 5 Prime and carry out a calibration of the PeriPod™ pumps if desired (see section 4.2 of the PeriPod™ Manual.). Note: The “Pod Change” message does not need to be accepted during priming or calibration.

4.2.2 Setting up the PeriPods

- 1 Connect the PeriPods™ in a daisy chain with the dosing cables. The dosing cable and the PeriPod™ connectors are colour coded to make this easier.
- 2 In the Connect™ Pro Controller Nutrient Dosing screen, enable Multi-part nutrient.
- 3 Click on the pump name of each nutrient pump and enter the name of the nutrient component it will be dosing (e.g., 5% Nitric, Grow A, Grow B etc.).

- 4 Select the pump function – pH, Nutrient (EC) or Off - by using the drop-down box for each pump. All pumps should be either set up or switched off.
- 5 Enter the nutrient quantities for each pump (probably taken from a nutrient feed schedule, or feed chart).

IMPORTANT

The Pro Controller will not use these numbers to dispense a particular quantity. Connect™ uses them to calculate nutrient proportions (these proportion are displayed as percentages, and can be seen changing as new quantities are entered). The Pro Controller/PeriPods™ will continue to dose in these proportions until the correct EC is reached.

- 6 Use the left and right arrows at the side of the screen to navigate between PeriPods™ in order to set up the pumps in each.
- 7 Save the setup to file, if it is likely to be used again. Click “Save to file...” and choose a location for saved files. A saved setup can be loaded and used by clicking “Load file...”
- 8 Click “Apply” to send the information to the Pro Controller/PeriPods.
- 9 Check all equipment is correctly installed and set up, and enter Control mode to start dosing. Nutrients will be dosed in the proportions entered from the feed chart line up to the required EC value.

IMPORTANT

Remember to set or check the EC and pH required values, on/off times and alarms, in Device Settings if loading a file, as these settings are not saved in the setup files.

See the Section 2.6.5 and 2.6.6 of this manual for more information on setting dosing settings.

4.2.3 Calculating the on time with multi-part nutrients

- 1 From the feed chart or schedule, find the **largest (by volume) nutrient component**.

Example: MaxiVeg requires 18 ml/gal – all the others take less.

FRODO'S FEED CHART

Week	Required pH	Required EC	Macro A	Macro B	MaxiVeg	Mega Micro 1	Mega Micro 2	Special Sauce
1	5.8	0.8	8	8		1 ml		
2	5.8	0.8	10	8	8	2 ml		
3	5.8	1.0	12	8	14	2 ml		1 ml
4	5.8	1.0	12	8	18	5 ml		3 ml
5	5.8	1.2	12	8	18	5 ml		3 ml
6	5.8	1.2	12	12			5 ml	3 ml
7	5.8	1.0	12	12			5 ml	3 ml
8	5.8	0.5	10	10			5 ml	

*all measures in ml/US gal and ppm 500 scale

- 2 Then, work out **how many doses are required** to take a reservoir from newly filled to dosed up. This is simply based on the required EC.
Example: 1.2 EC required = 12 (minimum) doses (We can only shift it 0.1EC with each dose – otherwise, we'll overshoot).
- 3 Work out **how much of the nutrient component is used** when fully dosing up the reservoir.
Example: Nutrient part A is added at the rate of 18 ml per gallon (from the schedule, above). My reservoir is 100 gallons so I need: 1800mls (1.8 litres) total.
- 4 Now we can work out **how big the maximum dose** should be,
Example: 1800ml total divided by 12 doses (found earlier) equals 150ml per dose.
 $1800/12 = 150\text{ml}$
- 5 Which gives us **the on-time** we need.
Example: My M3 pumps dose 120ml per minute, which is 2 ml per second, so
 $150/2 = 75\text{ seconds}$.

Remember, this is the **biggest we can have it**, so we can reduce it a bit, to stop overshooting. So, **60 seconds** would be a good starting point. It can be tweaked later, if needed.

5.0 Alarms & External Lockouts

5.1 Connecting alarm & external lockout cable

The Bluelab® Pro Controller can be connected to an external alarm or lockout device using the alarm & external lockout cable supplied.

- 1 Line up the dosing cable connector with the receptacle on the Bluelab® Pro Controller labelled 'ALARM'. Push and screw the collar fully into the receptacle.

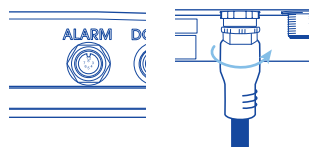

Line up connector pins

Push & twist

- 2 Connect the other end of the cable to an external alarm device. Refer to section 4.2 for functionality details.

5.2 Alarm & lockout cable functionality

The Bluelab® Pro Controller is supplied with an alarm and external lockout cable. It has two purposes:

1. It enables an external alarm to be fitted to the Bluelab® Pro Controller, such as a light or horn. This could be useful in a larger growing area, for example, where the controller is housed in a pump room, and not easily viewed.
2. It enables external devices such as flow switches and float switches to be used, so that external conditions can interrupt dosing.

External alarm connection

The controller closes a (normally open) electronic relay contact when in an alarm condition. This relay contact can be used as a switch to allow the function of an external alarm.

The internal relay operates between the **Grey** and **Pink** wires of the Alarm & Lockout cable. An example circuit is shown to the right.

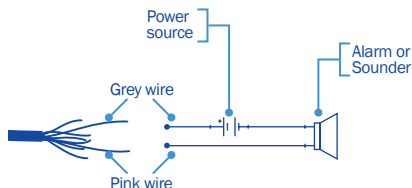

Note: The maximum voltage that the internal relay can be used to switch is 24VAC or DC with a maximum current of 250mA. These ratings must not be exceeded. If higher voltages or currents are to be switched, then an external relay, rated correctly for the desired device, must be used, driven by the internal relay.

Any connections to mains power or mains powered devices must be made by an appropriately qualified electrician.

5.2 Alarm & lockout cable functionality continued

External dosing lockout connection

The Bluelab® Pro Controller can be inhibited (locked out) from dosing in response to an external condition, such as a pump being switched off or having failed, or a float switch indicating a level is above or below a particular level.

There are two lockout circuits available: a normally open circuit (NO) which will inhibit the Bluelab® Pro Controller when a contact is closed, or a normally closed circuit (NC) which will inhibit the Bluelab® Pro Controller if a contact is opened. Multiple sensors/switches may be used in both circuits: in parallel with the NO circuit, and in series, with the NC circuit.

A cable sensing circuit is used to detect that the Alarm and Lockout cable is fitted.

The normally open circuit is between the **White** and **Yellow** wires. An example circuit is shown to the right.

Note: to enable the lockout functionality, the **Green** and **Yellow** wires must be connected.

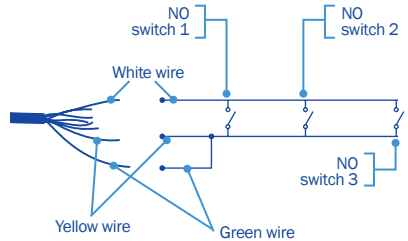

The normally closed circuit is between the **Brown** and **Yellow** wires. An example circuit is shown to the right.

Note: to enable the lockout functionality, the **Green** and **Yellow** wires must be connected.

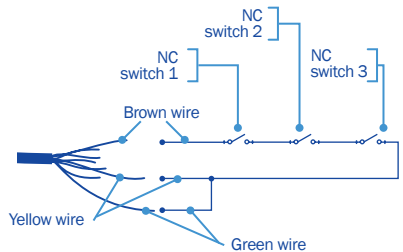

A combination of the above two circuits is also possible using the **Brown**, **White** and **Yellow** wires as shown to the right.

Note: to enable the lockout functionality, the **Green** and **Yellow** wires must be connected.

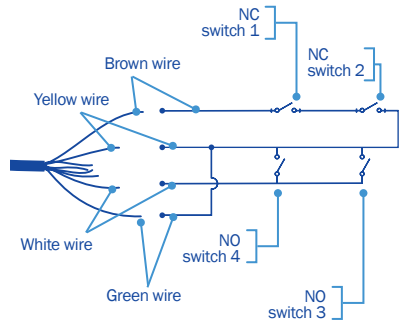

IMPORTANT

The choice of circuit used will be determined by the specific external sensor that is used. Refer to the Sensor Manufacturer's documentation for more information.



5.2 Alarm & lockout cable functionality continued

Alarm Cable wire key

Connector Pin #	Wire colour	Function
1	White	NO lockout switch
2	Brown	NC lockout switch
3	Green	Cable sense
4	Yellow	Ground
5	Grey	Alarm relay NO
6	Pink	Alarm relay COM
7	Blue	Not used
8	Red	Not used

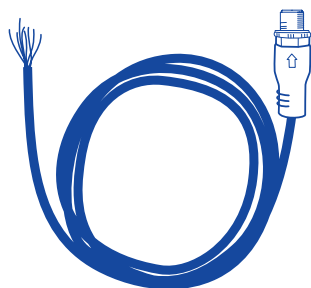

5.3 External lockout indicator

External lockout

The LED indicator is lit when a lockout condition is sensed via the alarm and external lockout cable. When sensed, all dosing will be stopped.

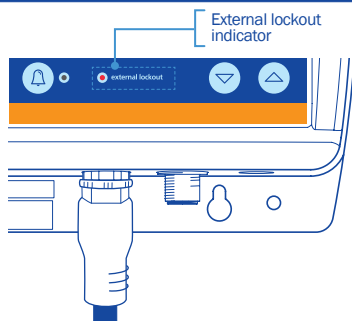

6.0 Probe Care & Maintenance

6.1 BlueLab® pH Probe care

pH probes **DO NOT** last forever. They age through normal use and will eventually fail. The life time of a pH probe depends on the environment it is used in and the way that it is treated. To receive a long life from your BlueLab® pH Probe, please ensure you follow the guide below.

pH probes contain glass and are therefore **FRAGILE**.
With good care, they will give a long service life.

BlueLab® pH Probe



DO NOT let the pH probe tip dry.

DO NOT bend the probe; this will break its internal glass tube.

DO NOT knock the probe; this will break its internal glass tube or external glass bulb.

DO NOT plunge a cold pH probe into a hot liquid, or a hot probe into cold liquid. Sudden temperature changes can crack the glass and permanently damage the probe.

DO NOT immerse in oils, proteins or suspended solids that will leave a coating on the glass bulb.

DO NOT 'kink' or bend the lead sharply.

DO NOT attempt to lengthen the lead on the pH probe.

DO NOT wet the BNC connector at the end of the lead.

Always remove pH probe storage cap before use

- 1 Grip the top of the cap and gently twist the base one rotation anticlockwise to loosen slightly.
- 2 Next slowly slide the cap off the pH probe. **DO NOT** completely remove the base of the cap from the top of the cap.
- 3 Store the storage cap in a safe place.

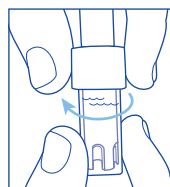

Removing pH probe storage cap

Storing the pH probe

When storing the pH probe, the pH probe tip must be kept moist.

To prepare the pH probe for storage, add enough BlueLab® pH Probe KCl Storage Solution to the storage cap so the probe tip is covered. Then replace the cap and store in a secure place. **DO NOT** use RO (Reverse Osmosis), Distilled or De-ionized water. Pure water changes the chemistry of the glass, damaging the probe.

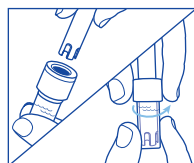

Ensure probe tip is covered by the KCl storage solution in cap

If the pH probe has been accidentally allowed to dry out; the pH probe must be 'hydrated' for 24 hours in KCl storage solution (never use RO, Distilled or De-ionized water). Following this; carry out a calibration. If the calibration fails, the probe may be permanently damaged.



6.2 Cleaning the Bluelab® pH Probe

To ensure accurate readings the pH probe tip needs to be rinsed in water after each use and cleaned prior to calibration using the following instructions.

The storage cap must always be put back on after cleaning. Always ensure it contains enough Bluelab® pH Probe KCl Storage Solution to cover the probe tip.

1 Remove storage cap from pH probe.

Hold the top of the storage cap, twist the cap to loosen then remove.

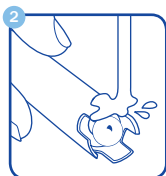
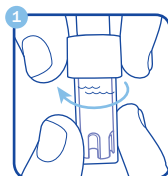

2 Rinse pH probe tip under fresh tap water.

Never use RO (Reverse Osmosis), Distilled or De-ionized water.

3 Fill a small plastic container with clean tap water.

Add a small amount of Bluelab® pH Probe Cleaner or mild detergent (dishwashing liquid).

4 Gently stir the probe tip in the mixture.

Ensure that you do not 'knock' the probe probe on the side of the container as this may cause damage to the probe.

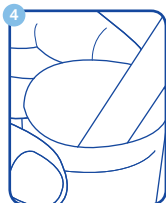

5 If the probe tip requires removal of heavy contamination: Gently brush around the glassware with a few drops of Bluelab® pH Probe Cleaner or mild detergent (dishwashing liquid) and a soft toothbrush.

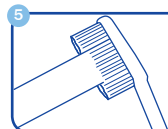

6 Rinse well under fresh running tap water to remove all traces of the detergent mixture.

7 Calibrate after cleaning, see section 2.6.7. After calibration, store pH probe in the storage cap, ensuring there is enough KCl Storage Solution to cover the probe tip.

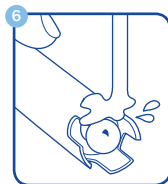

6.3 Hydrating the Bluelab® pH Probe

Hydrate the pH probe in Bluelab® pH Probe KCl Storage Solution when the probe tip has not always been stored in KCl storage solution, to improve the reading response speed, or the probe tip has been accidentally allowed to dry out.

1 Loosen, then remove the storage cap. Place the pH probe upright in a plastic container.

2 Clean the pH probe tip. Ensure the probe tip is cleaned before hydrating. See section 5.2 for instructions.

3 Add enough Bluelab® pH Probe KCl Storage Solution to a plastic container to submerge the pH probe tip.

4 Leave to soak for at least 24 hours. After hydration, always carry out a calibration to ensure accuracy. See section 2.6.7.

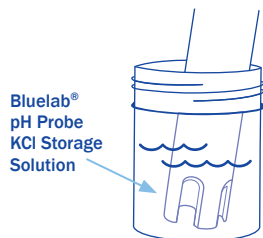



6.4 Cleaning the Bluelab® Conductivity Probe

Cleaning the conductivity probe periodically ensures accurate readings.

The conductivity probe is cleaned using the Bluelab® Conductivity Probe Cleaner, or “Jif” a trade name for a liquid scourer cream used in home bathrooms and kitchens. Similar products are called “Liquid Vim”, “Soft Scrub”, “Cif cream”, or “Viss”. Never use scented varieties as they may contain oils that contaminate the conductivity probe.

1 Remove shroud.

Hold the body and pull the shroud off.

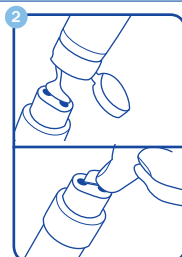
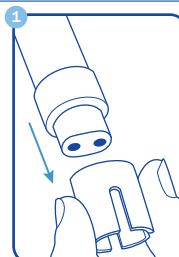

2 Clean the conductivity probe face.

Place one or two drops of Bluelab® Conductivity Probe Cleaner onto the probe face and rub with the Bluelab® Chamois or your finger firmly and vigorously.

3 Rinse the conductivity probe face.

Rinse off all traces of cleaner under running tap water while scrubbing the probe face with the other side of the Bluelab® Chamois or the same finger.



4 Check that the water forms a smooth film on the probe face. Ensure you have a clean, smooth film without any beads of water.

If you have beads of water, repeat steps 2 and 3.

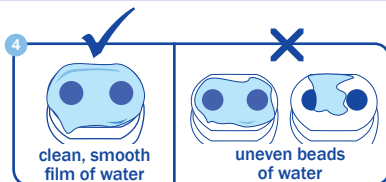

5 Refit the shroud and test in 2.77 EC Conductivity Standard Solution to ensure adequate cleaning.

Ensure the probe is dry. Water remaining on the probe will lower the conductivity of the solution. Place the probe tip into the solution, wait for the reading to stabilise to a constant value. This can take a few minutes while the probe adjusts to the temperature of the solution.

Repeat the cleaning process if the reading given is not within 0.1 EC, 1 CF, 50 ppm or 70 ppm of the values in the table below.

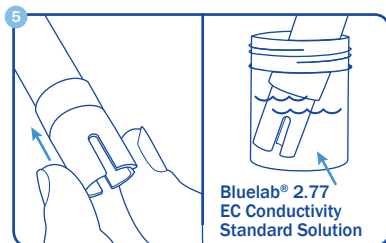

Testing the Bluelab® Conductivity Probe

The conductivity probe is tested in either 2.77EC/27.7CF/1385 ppm or 1939 ppm solution depending on the unit of conductivity chosen.

Use the standard solutions in the table to the right. Bluelab® solutions are recommended.

NOTE: The shroud **MUST** be on the probe when taking readings.

Unit chosen	EC	CF	ppm 500	ppm 700
Solution required	2.77	27.7	1385	1939
Expected reading	2.8	28	1400	1960
Acceptable error	± 0.1	± 1	± 50	± 70

7.0 Troubleshooting & Specifications

7.1 Troubleshooting guide

TROUBLE	REASON	CORRECTION
pH reading inaccurate	pH calibration old or not calibrated.	Carry out at least a 2 point pH calibration.
	pH probe dirty.	Clean and carry out pH calibration.
	pH probe damaged or old.	Replace pH probe.
	Previous pH calibration attempt has failed, and BlueLab® Pro Controller is using factory pH calibration.	Find cause of failed pH calibration, and recalibrate.
	Probe tip is not immersed.	Ensure pH probe tip is always immersed in the solution being measured.
pH calibration indicators flashing	pH calibration is over 30 days old.	Carry out a pH calibration.
pH calibration fails	Attempting to calibrate to pH 7 or pH 10 more than an hour after pH 7 calibration.	Carry out pH 7 calibration, then pH 4 or pH 10 calibration within 1 hour.
	pH probe dirty.	Clean and carry out pH calibration.
	pH probe damaged or old.	Replace pH probe.
Conductivity reading inaccurate	Conductivity probe or 2.77 EC solution contaminated.	Clean conductivity probe and check with Conductivity Standard solution.
	An air bubble is present on the conductivity probe surface.	Tap the conductivity probe to dislodge air bubble. Place conductivity probe in a position where air bubbles won't collect on its probe surface.
	Conductivity probe tip not immersed in solution.	Ensure conductivity probe tip is always immersed in the solution being measured.
Conductivity reading not what expected after EC calibration	2.77 EC solution old. Conductivity solution will change value over time, usually becoming stronger, as water evaporates.	Always use fresh solution, from well-sealed bottles/new sachets.
	Conductivity probe was wet when placed into EC solution, lowering value.	Ensure conductivity probe is dry before calibrating/checking, or rinse in conductivity solution first.
Temperature reading is inaccurate	Temperature probe not immersed in solution.	Ensure temperature probe is always immersed in the solution being measured.
	Temperature Probe damaged.	Replace temperature probe.
BlueLab® Pro Controller is overshooting required values	Dose on time is too long.	Reduce on time so 2-3 doses shifts 0.1EC/1CF/50TDS/70ppm or 0.1pH.
	Off time too short to allow reservoir to mix.	Increase off time. Can estimate mixing time by adding nutrient, and timing until new value stable.
	Dosing pump is too large for reservoir - minimum dose time (1 sec) is too long.	Choose smaller dosing system or dilute stock solutions.



7.1 Troubleshooting guide continued

TROUBLE	REASON	CORRECTION
An alarm value has been reached, but dosing in other measurements is still occurring	Alarms only lock out dosing in other measurement types if a control direction has been set in the measurement type in alarm.	Set a control direction so the alarm will lock out other measurement types, and set the required value so that dosing will not occur.
I want to reset all settings to factory defaults		Hold the brightness button down, and apply power. Release the brightness button when "FAC dEF" appears.

7.2 Bluelab® Pro Controller status displays

VALUE	DISPLAY		CONDITION
	Actual	Required	
EC			Conductivity has reached the high alarm value, in control or monitor mode, with alarms on.
			Conductivity has reached the low alarm value, in control or monitor mode, with alarms on.
			Conductivity has exceeded 5.0EC in control or monitor mode.
			Conductivity has become less than 0.0EC in control or monitor mode. May indicate a damaged probe.
			Conductivity has become less than 0.2EC in control or monitor mode, while the Low EC lockout is enabled.
			Conductivity probe is disconnected or damaged. Control or monitor mode.
Temperature			Temperature (in Celsius) has reached the high alarm value, in control or monitor mode, with alarms on.
			Temperature (in Celsius) has reached the low alarm value, in control or monitor mode, with alarms on.
			Temperature (in Celsius) has exceeded 50 °C.
			Temperature (in Celsius) has become less than 0 °C.
			Temperature probe is disconnected or damaged, when a control direction is set

7.2 Bluelab® Pro Controller status displays continued

VALUE	DISPLAY		CONDITION
	Actual	Required	
Temperature			Temperature (in Fahrenheit) has reached the high alarm value, in control or monitor mode, with alarms on.
			Temperature (in Fahrenheit) has reached the low alarm value, in control or monitor mode, with alarms on.
			Temperature (in Fahrenheit) has exceeded 50 °C.
			Temperature (in Fahrenheit) has become less than 0 °C.
			Temperature probe is disconnected or damaged, when a control direction is set.
pH			pH has reached the high alarm value, in control or monitor mode, with alarms on.
			pH has reached the low alarm value, in control or monitor mode, with alarms on.
			pH has reached a value lower than 0.0. May also indicate probe disconnected or damaged.
			pH less than 0. Monitor and Control mode.
EC			Conductivity is in ineffective control lockout (has dosed 15 times without sensing 0.1EC/1CF/50TDS/70ppm change, when IC lockout is enabled).
pH			pH is in ineffective control lockout (has dosed 15 times without sensing a 0.1pH change, when IC lockout is enabled).
Temperature			Temperature (in Celsius) is in ineffective control lockout (has dosed 15 times without sensing a 1 °C change, when IC lockout is enabled).
			Temperature (in Fahrenheit) is in ineffective control lockout (has dosed 15 times without sensing a 2 °F change, when IC lockout is enabled).
			The Bluelab® Pro Controller is in external lockout, caused by the normally open switch circuit.
			The Bluelab® Pro Controller is in external lockout, caused by the normally closed switch circuit.
			Device is in firmware update mode.

7.3 Technical specifications

	pH	Conductivity	Temperature
Units	pH	EC, CF, TDS (ECx500), ppm (ECx700)	°C, °F
Measurement Range	0.0 - 14.0 pH	0 - 5.0 EC, 0 - 50 CF, 0 - 2500 TDS (ECx500), 0 - 3500 ppm (ECx700)	0 - 50 °C, 32 - 122 °F
Control Range	0.1 - 13.9 pH	0.1 - 4.9 EC, 1 - 49 CF, 50 - 2450 TDS (ECx500), 70 - 3430 ppm (ECx700)	1 - 49 °C, 34 - 120 °F
Resolution	0.1 pH	0.1 EC, 1 CF, 50 TDS, 70 ppm	1 °C, 1 °F
Accuracy at 25 °C/77 °F	±0.1 pH	±0.1 EC, ±1 CF ±50 TDS, ±70 ppm	±1 °C, ±2 °F
Calibration	One, two or three point (pH 7.0, pH 4.0 and/or pH 10.0)	Optional	Not required (factory calibrated)
Temperature Compensation	Yes (If Conductivity probe in solution)	Yes	n/a
Operating Environment	0 - 50 °C / 32 - 122 °F, splash proof		
Power Source	Input: 100-240 Vac, 50-60 Hz, 5 VA, 4 interchangeable plug types (USA, Euro, UK, NZ/AUS) Output: 24VDC 0.4amp.		
Alarms & Lockouts	Alarm: visual, settings retained if power failure occurs. Settable high and low alarm lockout values.		
Dosing	On-time dosing: settable from 1 to 10 minutes in one-second steps. Off-time dosing: settable from 0 to 59 minutes and 50 seconds in 10 second steps.		
Signal Range	Indoor / Urban: 66 feet / 20 meters Outdoor / RF line-of-sight: 164 feet / 50 meters		
Frequency Band	2.4 GHz ISM		
System Requirements	Microsoft Windows XP or greater for BlueLab® Connect™ Software. Internet connection for remote access & data-logging to the cloud.		
Certifications	CE, FCC, IC. Contains Model XBEE2 Radio, IC: 4214A-XBEE2, FCC ID: OUR-XBEE2		



Bluelab® pH Up and pH Down Solutions

Optimum growth needs optimum pH. And we make optimum simple.

If your pH isn't in the right range – and that's 5.5-6.5 for most plant varieties – your nutrients are likely wasted.

We say that's a problem you don't need. At Bluelab®, we want our customers to have optimum growth and the best plants possible. So we've made it easy to raise or lower pH levels, whenever you need, and keep them just where they should be.

Bluelab®'s pH Up and pH Down are formulated to the highest standards. Just add what's required to lift or reduce growing solution acidity. Your plants will thank you for it. The main thing is, you'll see the difference in your harvest. Optimum inputs. Optimum results. Simple.



Available in:

› Bluelab® pH Up 500ml

› Bluelab® pH Up 1 Liter

› Bluelab® pH Up 1 Gallon

› Bluelab® pH Down 500ml

› Bluelab® pH Down 1 Liter

› Bluelab® pH Down 1 Gallon

Bluelab® pH Probe replacement

pH probes do not last forever.

They age through normal use and will eventually fail.

To ensure you receive a long life from your pH probe, please read the instructions provided with it.

When the time comes to replace your Bluelab® pH Probe all you have to do is order a replacement from your supplier!



Bluelab® Probe Care Kits

The instrument is only as accurate as the probe is clean!

Probe cleaning is one of the most important parts of owning and operating any Bluelab® meter, monitor or controller.

If the probe is contaminated (dirty) it affects the accuracy of the reading displayed.

Bluelab® Probe Care Kit range is available for:

- pH probe care
- pH & conductivity probe care
- Conductivity probe care

All the tools you need are included in each kit.

To re-stock your care kit, choose from the Bluelab® Solutions range.





Bluelab® Connect™ Range Extender

A Bluelab® Connect™ Range Extender boosts the data signal strength.

Extend the wireless range by positioning a range extender between your Bluelab® Connect™ devices and your Bluelab® Connect™ Stick.

Using the Bluelab® Connect™ Range Extender requires you to already have a Bluelab® Connect™ Stick and one or more Bluelab® Connect™ enabled devices.



Bluelab® pH Probe KCl Storage Solution

The perfect solution to store and hydrate your Bluelab® pH products.

Bluelab® pH Probe KCl Storage Solution is designed to increase response time and maximize the life of Bluelab® pH pens and pH probes.

For best results, use the KCl solution to store the pH pen/probe after use and hydrate monthly. *Instructions are on the label of the bottle.*



Use Bluelab® pH Probe KCl Storage Solution with:



› Bluelab® pH Pen

› Bluelab® pH Probes

› Bluelab® Soil pH Pen

› Bluelab® Soil pH Probes

Bluelab® limited warranty

Bluelab® Corporation Limited (Bluelab) provides a warranty on its products (Bluelab® Pro Controller™) under the following terms and conditions:



How Long Does Coverage Last?

Bluelab® warrants the Bluelab® Pro Controller™ (Product) for a period of 24-months from date of purchase by original purchaser or consumer. Proof of purchase, to Bluelab's sole satisfaction, is required for the warranty to be effective (store sales receipt for Product showing model number, payment and date of purchase). This warranty is non-transferable and terminates if the original purchaser/consumer sells or transfers the Product a third party.

What is Covered?

Bluelab® warrants the Product against defects in material and workmanship when used in a normal manner, in accordance with Bluelab® instruction manuals. If Bluelab® is provided with valid proof of purchase (as defined above) and determines the Product is defective, Bluelab® may, in its sole discretion either (a) repair the Product with new or refurbished parts, or (b) replace the Product with a new or refurbished Product.

Any part or Product that is replaced by Bluelab® shall become its property. Further, if a replacement part or Product is no longer available or is no longer being manufactured, Bluelab® may at its sole discretion replace it with a functionally-equivalent replacement part or product, as an accommodation in full satisfaction of the warranty.

What is NOT covered?

This warranty does not apply to equipment, component or part that was not manufactured or sold by Bluelab®, and shall be void if any such item is installed on a Product. Further, this warranty does not apply to replacement of items subject to normal use, wear and tear and expressly excludes:

- Cosmetic damage such as stains, scratches and dents
- Damage due to accident, improper use, negligence, neglect and careless operation or handling of Product not in accordance with Bluelab® instruction manuals, or failure to maintain or care for Product as recommended by Bluelab®
- Damage caused by use of parts not assembled/installed as per Bluelab® instructions
- Damage caused by use of parts or accessories not produced or recommended by Bluelab®
- Damage due to transportation or shipment of Product
- Product repaired or altered by parties other than Bluelab® or its authorised agents
- Product with defaced, missing or illegible serial numbers
- Products not purchased from Bluelab® or a Bluelab®-authorised distributor or reseller.

How Do You Get Service?

To begin a warranty claim you must return the Product to the point of purchase with valid proof of purchase (as defined above). In California, you can also return the Product to any Bluelab-authorised distributor or reseller, with valid proof of purchase.

Limitation of Liability & Acknowledgments

TO THE MAXIMUM EXTENT PERMITTED BY LAW, THIS WARRANTY AND THE REMEDIES SET OUT ABOVE ARE EXCLUSIVE AND IN LIEU OF ALL OTHER WARRANTIES, GUARANTEES AND REMEDIES (ORAL OR WRITTEN, EXPRESS OR IMPLIED).

EXCEPT AS PROVIDED IN THIS WARRANTY AND TO THE MAXIMUM EXTENT PERMITTED BY LAW, BLUELAB IS NOT RESPONSIBLE FOR SPECIAL, INCIDENTAL OR CONSEQUENTIAL LOSS OR DAMAGES, OR ANY OTHER LOSS OR DAMAGES RESULTING FROM SALE OR USE OF THE PRODUCT, OR BREACH OF WARRANTY, HOWEVER CAUSED, INCLUDING DAMAGES FOR LOST PROFITS, PERSONAL INJURY OR PROPERTY DAMAGE.

IT IS UNDERSTOOD AND AGREED BY CONSUMER UPON PURCHASE OF A PRODUCT THAT, EXCEPT AS STATED IN THIS WARRANTY, BLUELAB IS NOT MAKING AND HAS NOT MADE ANY EXPRESS OR IMPLIED WARRANTY OR OTHER REPRESENTATION REGARDING THE PRODUCT, AND DISCLAIMS ANY WARRANTY OF MERCHANTABILITY OR FITNESS FOR A PARTICULAR PURPOSE TO THE EXTENT PERMITTED BY LAW. ANY WARRANTIES WHICH ARE IMPOSED BY LAW AND CANNOT BE DISCLAIMED ARE HEREBY LIMITED IN DURATION TO THE PERIOD AND REMEDIES PROVIDED IN THIS WARRANTY.

SOME JURISDICTIONS (STATES OR COUNTRIES) DO NOT ALLOW EXCLUSION OR LIMITATION FOR INCIDENTAL OR CONSEQUENTIAL DAMAGES, OR LIMITATION ON HOW LONG AN IMPLIED WARRANTY LASTS, SO THE ABOVE LIMITATION OR EXCLUSION MAY NOT BE APPLICABLE.

IF ANY PROVISION OF THIS WARRANTY IS JUDGED TO BE ILLEGAL, INVALID OR UNENFORCEABLE, THE REMAINING PROVISIONS OF THE WARRANTY SHALL REMAIN IN FULL FORCE AND EFFECT.

Governing Law; Authority

This warranty is governed by the laws of the state of country where Product is purchased, without regard to its choice of law principles. Except as allowed by law, Bluelab does not limit or exclude other rights a consumer may have with regard to the Product. No Bluelab distributor, employee or agent is authorised to modify, extend or otherwise change the terms of this warranty.

Register your guarantee online at bluelab.com





guarantee.

The Bluelab® Pro Controller™ comes with a 2 year limited written guarantee. Proof of purchase required.



connect.

If you need assistance or technical advice - we're here to help you.

North America Phone: +1 909 599 1940

New Zealand Phone: +64 7 578 0849

New Zealand Fax: +64 7 578 0847

Netherlands Phone: +31 (0) 85 05 16 848

Email: support@bluelab.com

Online: facebook.com/getbluelab

Manuals: bluelab.com



location.

Bluelab® Corporation Limited

8 Whiore Avenue, Tauriko Business Estate

Tauranga 3110, New Zealand



Instruction Manual English CONPRO_620374_V02_28032018

© Copyright 2018, all rights reserved, Bluelab® Corporation Limited