

CONDITIONS OF OPERATION

Adjusting the Light Rail 5.0 Commercial Drive variable time delay will be up to you, as all gardens are different. We suggest first setting the delay to 30 seconds. Then after observing your plant growth you may want to change the length of delay. A longer delay would dictate more light on the ends and less in the middle. A shorter delay would be visa versa.

The first few weeks of operation will be the Drive Motors break-in period. The trolley wheels will turn gray as well as shed some nylon. The Drive Wheels O-Ring may turn silver, and it too will shed some skin. These are both normal conditions as the moving parts of the Drive Motor conform to their prospective grooves of the Rail.

After several weeks of operation you may notice a slight pause as the Drive Motor starts up after changing direction, this is normal. It is the D Hole of the molded Drive Wheel showing some wear and loosening up upon the Drive Motors' shaft. Again this is normal and is a good thing as it will allow the Drive Wheel to self adjust upon the Motors' shaft. As for the pause when the Drive motor changes direction, this also is normal and good. It will reduce the load on the gear train while changing direction.

It is a good idea to use a timer on the Drive Motor. After all, the lamp need not be moving when the lights are out. This period of off time adds up, and will greatly reduce wear on the Drive Motor.

You should wipe the Rail off with a dry cloth from time to time. If cleaning the rail becomes necessary use rubbing alcohol or window cleaner. Never use any petroleum or wax based substance on the rail or the rubber drive wheel.

If drive wheel slippage should ever become an issue, it is OK to clean the drive wheels rubber tires. Again use rubbing alcohol or window cleaner. Never use any petroleum or wax based substance on the rail or the rubber drive wheel.

LIGHT RAIL *5.0 LIMITED LIFETIME WARRANTY

A. Gualala Robotics Inc. warrants this Light Rail 5 Drive Motor to be free from defects in materials and workmanship for its usable lifetime. Gualala Robotics Inc. will repair or replace such product or part thereof which, upon inspection by Gualala Robotics Inc., is found to be defective in materials or workmanship. This lifetime warranty is limited to non serviceable items only and does not include drive and trolley wheels. As a condition to the obligation of Gualala Robotics Inc. to repair or replace such product, the product must be returned to Gualala Robotics Inc. together with proof-of-purchase satisfactory to Gualala Robotics Inc.. This warranty is non transferable.

B. The Proper Return Authorization Number must be obtained from Gualala Robotics Inc. in advance of return. Call Gualala Robotics Inc. at 303 861 1266 to receive the Return Authorization Number to be displayed on the outside of your shipping container.

You must send your dated sales receipt along with a written statement setting forth the name, address, and daytime telephone number of the owner, together with a brief description of any claimed defects and the drive unit to Gualala Robotics, Inc., 14704 East 33rd Place, Unit H, Aurora, CO 80011. You must pay shipping to the factory. After repair or replacement of your drive unit, Gualala Robotics will ship it back at no charge. Parts or product for which replacement is made shall become the property of Gualala Robotics Inc..

Gualala Robotics Inc. shall use reasonable efforts to repair or replace any Light Rail 5 Drive Motor covered by this limited warranty within fifteen days of receipt. In the event repair or replacement shall require more than fifteen days, Gualala Robotics Inc. shall notify the customer accordingly. Gualala Robotics Inc. reserves the right to replace any product which has been discontinued from its product line with a new product of comparable value and function. This warranty shall be void and of no force of effect in the event a covered product has been modified in design or function, or subjected to abuse, misuse, mishandling or unauthorized repair. Further, product malfunction or deterioration due to normal wear is not covered by this warranty.

GUALALA ROBOTICS INC. DISCLAIMS ANY WARRANTIES, EXPRESS OR IMPLIED, WHETHER OF MERCHANTABILITY OF FITNESS FOR A PARTICULAR USE, EXCEPT AS EXPRESSLY SET FORTH HEREIN. THE SOLE OBLIGATION OF GUALALA ROBOTICS INC. UNDER THIS LIMITED WARRANTY SHALL BE TO REPAIR OR REPLACE THE COVERED PRODUCT, IN ACCORDANCE WITH THE TERMS SET FORTH HEREIN. GUALALA ROBOTICS INC. EXPRESSLY DISCLAIMS ANY LOST PROFITS, GENERAL, SPECIAL, INDIRECT OR CONSEQUENTIAL DAMAGES WHICH MAY RESULT FROM BREACH OF ANY WARRANTY, OR ARISING OUT OF THE USE OR INABILITY TO USE ANY GUALALA ROBOTICS INC. PRODUCT. ANY WARRANTIES WHICH ARE IMPLIED AND WHICH CANNOT BE DISCLAIMED SHALL BE LIMITED IN DURATION TO A TERM OF ONE YEAR FROM THE DATE OF ORIGINAL RETAIL PURCHASE.

Some states do not allow the exclusion or limitation of incidental or consequential damages or limitation on how long an implied warranty lasts, so the above limitations and exclusions may not apply to you. This warranty gives you specific legal rights, and you may also have other rights which vary from state to state. Gualala Robotics Inc. reserves the right to modify or discontinue, without prior notice to you, any model or style Light Rail 5 Drive Motor. If warranty problems arise, or if you need assistance in using your Light Rail 5 Drive Motor contact:

Gualala Robotics Inc.
14704 East 33rd Place
Unit H
Aurora CO 80011

Tele: 303 861 1266
Fax : 303 371 1832

NOTE: This warranty is valid to U.S.A. and Canadian customers who have purchased this product from an Authorized Gualala Robotics Inc. Dealer in the U.S.A. or Canada. Warranty outside the U.S.A. and Canada is valid only to customers purchased from a Gualala Robotics Inc. International Distributor or Authorized Gualala Robotics Inc. Dealer in the specific country and please contact them for any warranty service

*TM PATENTED

REPLACEMENT PARTS

Like all moving mechanical objects, parts wear out. i.e. your new car will need new brakes and tires someday. At some point in time your Drive Motor will need some parts as well. As not all Light Rail *5.0 Dealers stock these parts, you may want to order them today, so you will have them on hand when needed.

Gualala Robotics, Inc. offers a refurbish kit for sale direct from the factory. It contains one (1) DRIVE WHEEL ASSEMBLY as well as one (1) TROLLEY WHEEL KIT with INSTRUCTIONS and FASTENERS. This refurbish kit sells for \$26.95. If you are interested in obtaining this refurbish kit, simply fill out the form below and send it and a money order payable to Gualala Robotics. We will fill your order promptly. Sorry, no C.O.D. or checks; credit card orders should visit www.lightrail5.com

Gualala Robotics, Inc. offers refurbish services for non-warrantable drive motors and a range of refurbished motors and part kits at www.lightrail5.com. If you have an older Light Rail 3 or 3.5 and it is not working or not working to expected standards. Go to www.lightrail3.com for details about how you can get your older Light Rail 3.5 Drive Motor refurbished at the factory or upgraded into a Light Rail 4.0.

REPLACEMENT PARTS ORDER FORM

Please send me _____ Refurbish Kit(s) @ \$26.95 (U.S. dollars) each. Included is my money order payable to Gualala Robotics.

NAME _____

ADDRESS _____

CITY _____ STATE _____ ZIP _____

LR5



IMPORTANT SAFETY INSTRUCTIONS

Manufactured by Gualala Robotics, Inc., 14704 East 33rd Place, Unit H, Aurora, CO 80011. *FOR USE WITH GROW LAMPS THAT ARE U.L. LISTED AND / OR C.S.A. CERTIFIED.* RISK OF FIRE AND ELECTRICAL SHOCK, THIS PRODUCT REQUIRES PROPER FIELD WIRING AND IS INTENDED TO BE INSTALLED BY A QUALIFIED ELECTRICIAN ONLY.

Please read these instructions and the operating instructions before installing your unit. The instructions supplied with your unit contain important information. Review all documentation before installing your unit.

1. Dropping this unit will cause serious damage to it.
2. Straight and secure Rail mounting is essential for both safety and operation. If you are inept at this sort of thing, hire a carpenter or ask a friend who is one. Refer to STEP TWO of the mounting instructions inside.
3. If you are using chain and/or hooks to hang your Grow Light from the drive unit, be sure they are load rated to handle the weight of your Grow Light.
4. This unit is rated for use on specific voltage identified by a label fastened to your unit. Never use this unit on a different voltage than specified.
5. Your unit is equipped with a 3-Wire grounding type electrical plug. This unit will only fit into a grounding-type outlet and is a safety feature. DO NOT DEFEAT THE GROUNDING CONNECTION. If you are unable to insert the plug into an outlet, call an electrician to replace the obsolete electrical outlet.
6. After installation, be sure there is plenty of slack in power cords as described in STEP FIVE of instructions.
7. The electrical portion of this unit is non-serviceable. Do not attempt to remove the switch box cover under any circumstances. If unit fails to operate due to an electrical malfunction, unplug, remove from Rail and return to manufacture.
8. Always unplug unit if: you are adjusting Grow Light Height; removing Drive Unit for service; or any procedure. A moving Grow Light warrants Danger.
9. WARNING: Never wire/hook this unit to your lamps/lights ballast, it will cause damage to the motors circuitry.

LIGHT RAIL 5 INSTALLATION INSTRUCTIONS

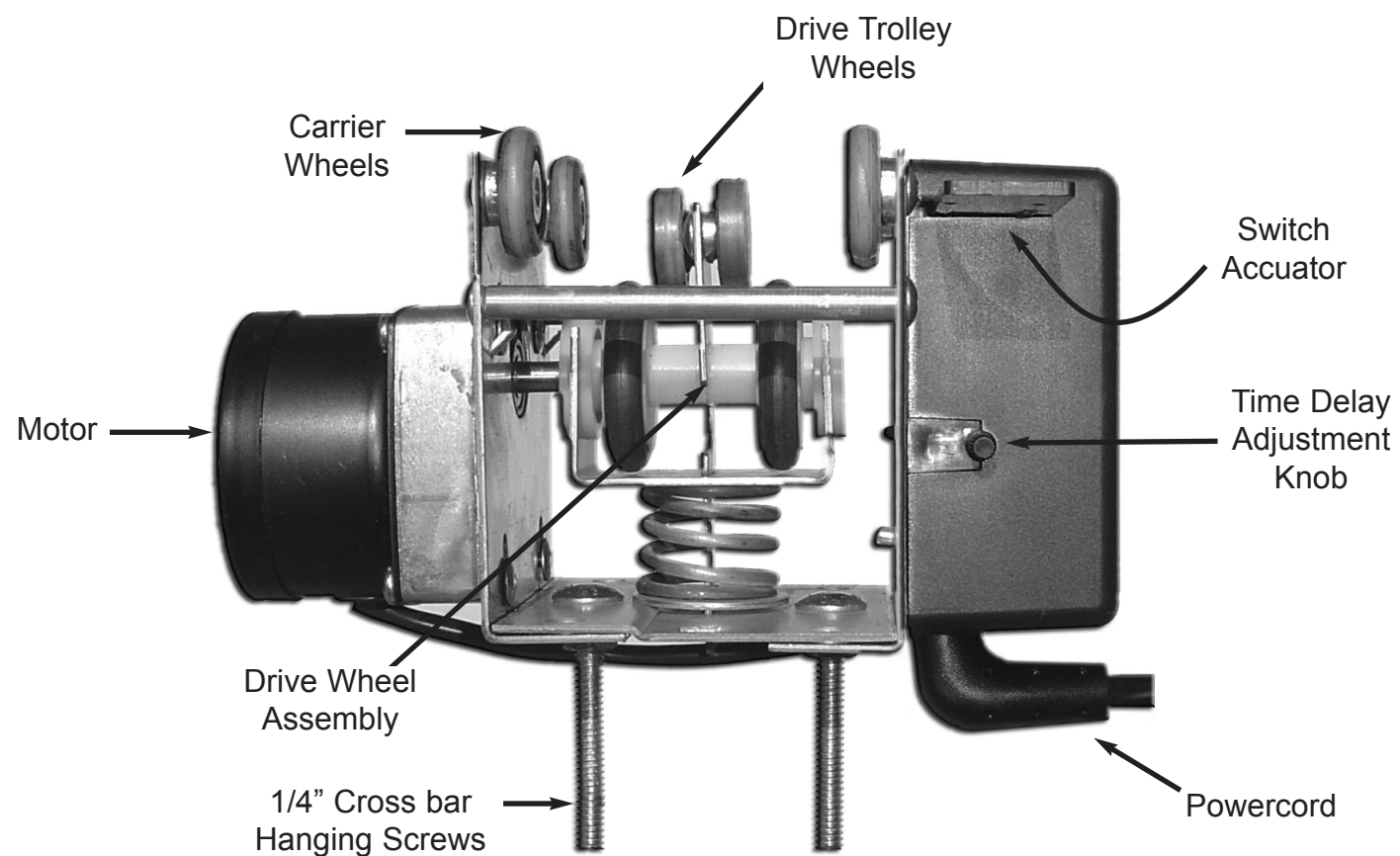

Assembly Tools Required

Phillips head screwdriver, tape measure, chalk line or string, drill, phillips driver bit, 1/8" drill bit, 7/16" wrench, pliers.

STEP FIVE: HANGING LIGHTS

At this time you can remove the yellow tag and wire tie on the Drive Motor. **Now** your ready to hang your lights. **Below** are some suggestions for doing so.

As you hang the first light, the unit will become very unbalanced and tip to one side. Don't worry about it, just be careful, it will even out when you hang the second light. Or if another person is available, they can hold the opposite end while you hang the first light. We do not recommend trying to hang both lights simultaneously. We've tried. It does not work very well.

Ridged mounting lights to the cross bar is not recommended. Many horizontal reflectors incorporate wire vee hooks. We recommend using them or use chains and hooks to allow for lamp height adjustment.

Running the cords can be a cumbersome task. It is important that the Drive Motor can travel its full distance to both ends without restriction from the cords. Some say it is best to bring the cords in from the side rather than bringing them in from the end. After bundling the cords together, run the system down to both ends to find the correct fastening point of the cords. Then fasten them to the ceiling or the wall leaving enough slack so the Drive Motor can travel its full distance to both ends without restriction

Things to check before operation.

1. Straight, level and secure rail mounting is essential for both safety and operation. Please be sure of this.
2. Make sure the switch stop eye screws are tight and make contact with the Drive Motors switch actuator.
3. Be sure the lamps are hung securely from the crossbar
4. If the cross bar is not level, you can adjust the wing nuts to help level the bar.
5. Be sure the Drive Motor can travel its full distance to both ends without restriction from the cords.
6. Be sure the yellow tag and wire tie have been removed from the Drive Motor

STEP FOUR: INSTALLING THE CROSS BAR

Tools you will need: 7/16" wrench, Pliers



1 - Cross bar splint



2- 1/4" x 1 1/2"
Crossbar to Splint Screws



2 - Cross bar ends



10 -1/4" Hex Nuts



4 - Lamp Hanging
Eye Screws



2 - 1/4" Wing nuts

Start by inserting the 2 cross bar ends into the cross bar splint.

Next align the holes in the cross bar splint with the holes in the cross bar. There are 3 holes in each side of the splint to accommodate different cross bar widths. You must use the same holes in each side so the cross bar ends span an equal distance from the center of the splint. (fig. 4-1)

After inserting the 2 cross bar ends into the cross bar splint secure them using the 2 - 1/4" x 1 1/2" Crossbar to Splint Screws and 2 of the 1/4" Hex Nuts. (fig. 4-2)

Next install the 4 - Lamp Hanging eye screws with the remaining 1/4" Hex Nuts (fig 4-3). There are two sets of holes on each end to accommodate different light widths. Also, as in the Light Rail 5 logo you can see the cross bar ends are bent. If you have a particularly high ceiling you may want to hang the crossbar with the bends down opposite the logo. This you will need to decide so the 1/4" eye screws are mounted facing the right way.

Now that the cross bar is assembled it can be mounted to the Drive Motor. Locate the two holes in the center of the cross bar splint. Slide them over the two 1/4" screws protruding from the bottom of the Drive Motor and fasten it using the 2 - 1/4" Wing nuts fig 4-4. Be sure to tighten the wing nuts until the 1/4" screws on the bottom of the drive motor begin to protrude from the bottom of the wing nuts. (fig. 4-4)

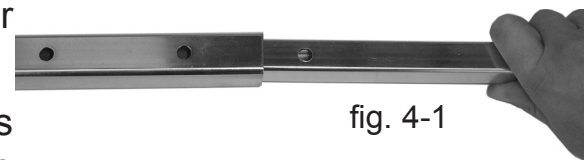
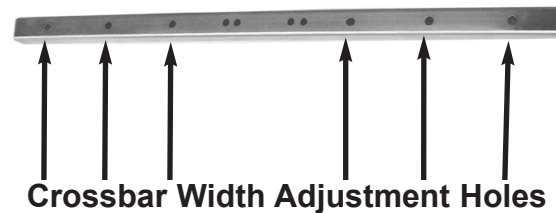

fig. 4-1



Crossbar Width Adjustment Holes



fig 4-2



fig 4-3



fig 4-4

STEP ONE: RAIL ASSEMBLY

Tools you will need: Phillips head screwdriver



2 - Rail Halves



1 - Rail Coupler



2 - Slide Nuts



4 - #10 x 3/8"
Machine Screws



Fig 1-1

Start by matching ends of rail halves with arrows. While making sure the alignment pins line up with their corresponding holes, push the two rail halves together (Fig 1-1); if needed you can tamp the rail end on the floor to assist in pushing the rail halves all the way together (Fig 1-2).

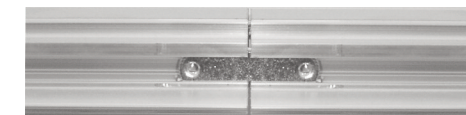

Fig 1-3

Next insert one slide nut in the slide nut channel on each side of the rail. Push them towards the middle until they cover the joint where the 2 rail halves meet. (Fig 1-3)

Last slide the rail coupler over the top of the rail and start each of the 4 - #10 machine screws into the threaded holes in the slide nuts (Fig 1-4). Tighten them just until they are snug, then stand the rail on its end and torque the screws tight while pushing down on the rail. (Fig 1-5)



Fig 1-4



Fig 1-2



Fig 1-5

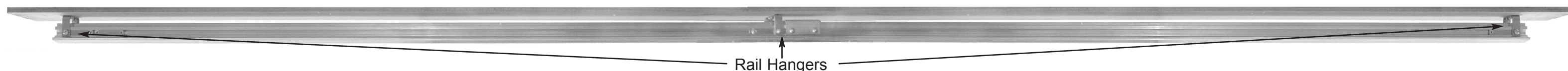

STEP TWO: HANGING YOUR RAIL

Tools you will need: Tape measure, chalk line or string, drill, phillips driver bit & 1/8" drill bit.



3 - Rail Hanging Brackets



6 - #10 x 1" Wood Screws

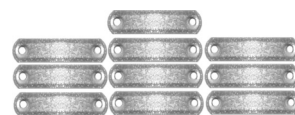

10 - Slide Nuts



6 - #10 x 3/8 Machine Screws

Warning: straight, level and secure rail mounting is essential for both safety and operation. Mounting the rail should be done by a capable person. If you do not think you're capable. Hire a carpenter or ask a friend who is one.

NOTE: if you are mounting to a finished ceiling you must locate the joist beneath the drywall and mount to it. Never mount rail hanging brackets into drywall only. Also, we do not recommend using drywall anchors for mounting into drywall material. In addition, if you are mounting to joist under drywall you must use screws longer than the ones provided.

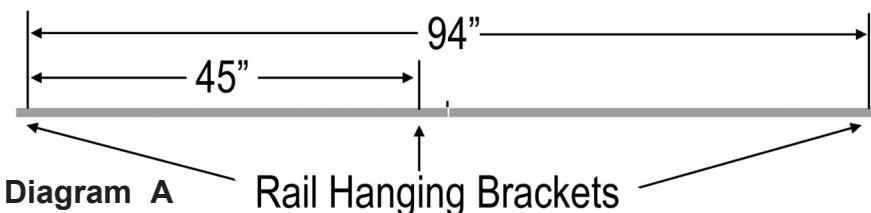

You will be using the 3 rail hanging brackets, 6 slide nuts and 6-#10 machine screws to hang the rail. Refer to diagram A for the rail hanging bracket locations.

It may be best to mount the assembled rail to a board and then mount that assembly above your garden, a good wood for this method is 1"x 6"x 10 foot Pine or Cedar. Either can be found at your local lumber store in ten foot lengths.

Note: Remember to install the adjustable switch stop slide nut into rail channel prior to mounting as the slide nut can not pass the mounting hardware on the end once installed.

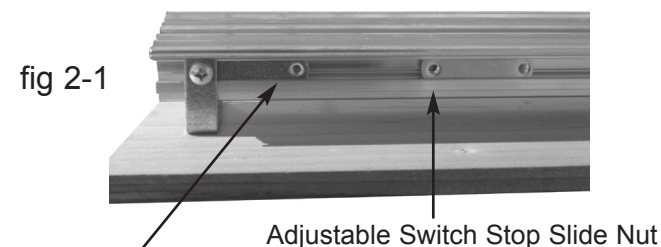

fig 2-1

If you will be mounting the rail in line on a ceiling joist, the rail will need to be hung after the board is mounted to the joist. However it is easier to first mount the rail hanging brackets to the board.

Before mounting the rail to the rail hanging brackets, slide the remaining 8 slide nuts into the slide nut channel on the rail. 4 on each side, 2 from either end as the slide nuts can not pass by the middle of the rail because of the coupler.

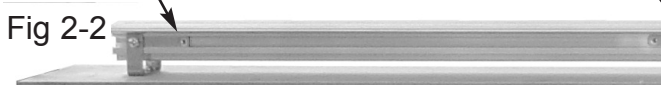

Fig 2-2



Fig 2-2

Then, slide the rail into the rail hanging brackets and fasten them to the slide nuts closest to the ends as well as the slide nuts that line up with the center rail hanging bracket using the remaining #10 machine screws. When you're finished hanging the rail it must be mounted by one bracket on each end and one bracket in the middle near the coupler. Additionally there should be 1 unused slide nut on each side of the rail, either left or right of the coupler. These can be used for adjustable switch stops if desired. (Fig.2-1 and 2-2)

STEP THREE: INSTALLING DRIVE MOTOR AND SWITCH STOPS

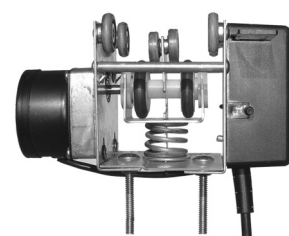

1 - Drive Motor



2 - Switch Stop Eye Screws

IMPORTANT: You must allow the Drive motor to drive itself onto the rail, as it is impossible to push the drive motor onto the rail.

Start by plugging the Drive motor into its rated (check drive motor label) VAC power source.

Next pay close attention to the Drive Motors drive wheel assembly located in the center of the Drive Motor (fig. 3-1) With the motor running and the switch actuator in the forward position, line the small white trolley wheels up with the corresponding square channel in the center of the rail. Gently push the drive wheel assembly towards the rail and it should drive itself onto the rail (fig 3-1). If it won't drive itself onto the rail, check that the switch actuator is in the forward position, (pushed towards the rail)

Line Small White Trolley Wheels with center channel

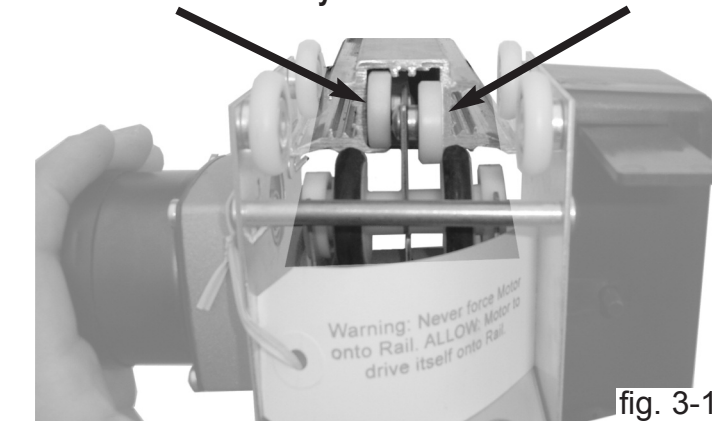

fig. 3-1

Now that the drive motor has driven itself onto the rail, unplug it and install the switch stop eye screws. If you would like the drive motor to travel the full length of the rail, install them in the remaining slide nut screw holes next to the rail hanging brackets at the ends of the rail. If you desire a shorter travel distance you can use the remaining unused slide nuts installed before you hung

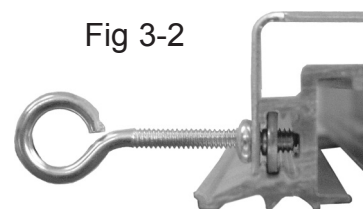

Fig 3-2

the rail (Fig 2-1 and 2-2) and slide them to any desired location. Make sure you install the switch stop eye screws on the same side of the rail as the switch actuator on the Drive Motor, and tighten them until the eye of the screw is vertical so the switch actuator will make contact (Fig 3-2).